



© GREG GENT STUDIOS



WB Mfg
Wisconsin Bench Manufacturing

We Can.
DESIGN. BUILD. DELIVER.

wibenchmfg.com

Catalog

Overview Pages: 6-7

Overview	6-7
----------	-----

Work Surfaces Pages: 8-15



Butcher Block & ShopTops®	10-11
Stainless Steel & Lab Tops	12-13
Standard & Lotz Armor Edge™ Laminate Tops	14
3mm Edge, T-Mold & Postformed Laminate Tops	15

Shelving Pages: 16-19



Shelving Overview	18-19
-------------------	-------

Locker Rooms Pages: 20-39



Laminate Bench	22-23
Locker Bench	24-27
Team Locker	28-29
World Famous Locker	30-33
REplay® Laminate Locker	34-36
Cubbies	38-39

Seating Pages: 40-47



Square Tube Stool	42-44
Chrome Tube Stool	45-46
Task Chair	47

Options Pages: 48-51



Top Options	48-49
Power Options	50-51

LOBO Series Pages: 52-55



LOBO Table	52-55
------------	-------

TORO Series Pages: 56-59



TORO Table	56-57
TORO Desk	58-59

ELO® Series Pages: 60-83



ELO® Café Table & Stool	60-61
ELO® Table & Desk Overview, Leg Options	62-63
ELO® Tables	64-77
ELO® Desks	78-83

UNE-T Series **Pages: 84-87**



UNE-T Overview	84-85
UNE-T Table & Workstation	86
UNE-T Desk	87

Activity Series **Pages: 88-91**



Activity Table	88-91
----------------	-------

GEO Series **Pages: 92-93**



GEO Lift Lid Desk	92-93
-------------------	-------

Teacher's Furniture **Pages: 94-97**



Teacher's Mobile Desk & Lectern	94-95
Mobile Lab Workstation & Instructor Desk	96-97

Flip Top Series **Pages: 98-99**



Flip Top Table	98-99
----------------	-------

Conference & Training Furniture **Pages: 100-103**



Multimedia Team Table	100-101
Conference Table	102-103

Workstations **Pages: 104-107**



Study Carrel & Information Kiosk	106-107
----------------------------------	---------

Collaborative Workstations **Pages: 108-111**



Collaborative, Tomah & Urban Edge Workstations	108-111
--	---------

Modular and Mobile Storage **Pages: 112-125**



Transporter Mobile Storage	114-115
Combination Tall Storage, Portfolio & Tote Tray Storage	116-117
Tote Storage Unit	118-119
Flat Storage	120-121
Tech Storage Cabinet	122-123
3D Printer Station	124-125

Rhapsody® Music Storage

Pages: 126-137



Rhapsody® Music Storage Overview	128-129
Compartment Cabinets	130-133
Folio & Uniform Storage, Stringed Instrument Storage Rack & Percussion Station	134-136

REplay® Modular & Mobile Casework

Pages: 138-155



REplay® Cabinet Overview	140-141
Open Base, Double Sided Bookcase, Door & Drawer Cabinets	142-143
Drawer Base, Sliding Door Base & Sink Base Cabinets	144
Tech Base Cabinets	145
Tall Cabinets	146
Mobile Open Base, Bookcase Double Sided, Curved Bookcases, Door & Drawer Cabinets	147
Mobile Door & Drawer Cabinets & Mobile Drawer Base Cabinets	148
iXchange Learning Wall System	152-153
High Density Storage	154-155

CaseworkUSA®

Pages: 156-181



CaseworkUSA® Overview	158-159
Open Base Cabinets	160
Drawer & Door Base Cabinets	161-165
Drawer Base Cabinets	166-167
Corner Base Cabinets	167
Blind Corner Base & Sink Base Cabinets	168
Open Wall & Door Wall Cabinets	169-171
Corner Wall Cabinets	171
Blind Corner Wall & Accessory Wall Cabinets	172
Mail Slots	173
Open Tall Cabinets	174
Single Door Tall Cabinets	175
Double Door Tall Cabinets	176-179
Wardrobe Tall Cabinets	179
Casework Accessories	180

Healthwork

Pages: 182-191



Healthwork Overview	184-185
Base Cabinets	186
Wall & Tall Cabinets	187
Speciality Cabinets	188

Accessories Pages: 192-193

Accessories & Book Box/Tote Tray Chart	192-193
--	---------

Warranty Pages: 194-197

We Can. Design. Build. Deliver.	194-195
WB Manufacturing Warranty	196
Green Initiatives	197

Standard Finishes Pages: 198-199

Standard Finishes Overview	198-19
----------------------------	--------

We Can. DESIGN. BUILD. DELIVER.

WB Manufacturing can **design** the solutions to meet your environments. Choose from our vast array of furniture and cabinet standards or talk directly to our in-house Design Team to customize products to fit your space.

We can **build** it. With over 100 skilled American workforce professionals in our plant in Thorp, Wis., WB Manufacturing can build what you need when you need it. At WB, we use quality materials and processes to ensure affordable, durable, long-lasting products backed by a comprehensive warranty.

We can **deliver**. Yes, we can facilitate timely, affordable shipment of your products, but we can also “deliver.” Deliver the best product, the best customer service and the best solutions for what we hope is the best experience one can have when fulfilling educational, office, health care and industrial needs.

At WB Manufacturing... **We Can.**



have questions? need information

Call us:

800.242.2303



Customer Service is available 7:30 am - 4:30 pm CST Monday through Friday. We are available to assist you during the planning stage, during the installation and after the clean-up.

Visit our website:

wibenchmfg.com



You'll find product specifications and brochures, images and installation gallery, products for specific vertical and horizontal applications and more on our updated website.

Request design services:

info@wibench.com



Our Engineering, Project Management and Estimating Teams can assist with room layout and project elevation drawings.

Send an order or quote:

info@wibench.com



Request for quotes, project registration, shipping or order processing instructions and purchase orders can be easily handled through this email address.

Track your order:

extranet.wibench.com



Customers can simply access information on their orders and shipment status via our extranet.



507 E. Grant St.
Thorp, WI 54771
P - 800.242.2303 F - 715.669.5929



Look for FSC® certified products (FSC-C100379)

tops furniture casework modular mobile

Every environment requires active, semi-active and permanent solutions. At WB Manufacturing, **We Can** design, build and deliver your casework, modular, mobile, furniture and top requirements:



furniture Active

Furnishings need to be functional, versatile and strong. WB Manufacturing can design, build and deliver tables and desk tops with the correct shape and size work surfaces to accommodate the 21st century classroom. WB provides the strength of fully welded frames, high pressure laminate tops and indestructible edge banding to endure your active environment.



mobile Active

Flexible storage is a must in the classroom, allowing the teachers, staff and students to have storage within easy reach. Mobile storage -- bring it to the lesson area regardless of where the learning is taking place. Heavy duty casters, optional whiteboard panels, from supplies to technology can now be easily accessible anywhere.

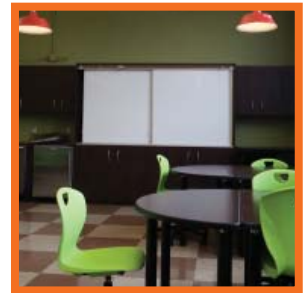

modular Semi-Active

Repositionable REplay® cabinets are designed to provide maximum flexibility and savings in the high-impact learning environments. These fully finished, stand alone, repositionable cabinets can now be installed as a semi-permanent fixture with the turn of a knob or used as furniture, the best of both options.



tops
Permanent

From labs to store rooms or counter tops to shelves, the flat work surface is often the last piece of the furnishings to be finalized. WB Manufacturing has been delivering shelving and counter tops for almost every environment for the past 30 years. We don't plan to stop anytime soon.



casework
Permanent

After successfully incorporating mobile and modular storage into your learning spaces, having long-term permanent storage completes the entire storage requirements. Rely on standard or specialized casework for labs, general classrooms, administrative and maintenance areas, libraries and fitness centers.

We Can.

DESIGN. BUILD. DELIVER.

Solutions

from WB Manufacturing

When it comes to casework, tables, desks and tops...**We Can.** WB Manufacturing can design, build and deliver standard cabinets and lockers, modular casework, mobile furniture and custom solutions for any environment, any market, anywhere, anytime. From fixed solutions for non-active environments, to custom modular and mobile units for active and semi-active installations, our in-house Design Team is ready to assist you. By the room, floor or building and whether you're renovating an existing space or designing and constructing a new space, **We Can. Design. Build. Deliver.**



JC Edwards & Son



Work Surfaces

from WB Manufacturing

Not only has WB Manufacturing been a leader in benchtops and work surfaces for over 35 years, we are a leading supplier of OEM tops for manufacturers of work benches, shelving, tables and desks. From commercial work benches to industrial material handling tables and storage racks to the lab, race shops and electrical assembly stations -- WB Manufacturing can design, build and deliver standard and custom work surfaces tailored to meet your needs, whether they are laminate, stainless steel, phenolic, epoxy or hardwood.





Butcher Block Top

We are Hardwood Tops

Ideal for electrical or tool and die work, butcher block benchtops are rugged, yet yielding enough to provide a safe surface for precision tools. Our butcher block tops are crafted from face-glued hardwood strips, sanded to a smooth finish for outstanding strength and quality appearance.

wood



ShopTop®

WB Signature Tops

For years of lasting strength and rugged treatment, select our composite ShopTop® that sandwiches a medium-density fiberboard (MDF) or lumber core between two layers of 1/2" industrial grade particle board. ShopTop® is non-conductive and splinter-proof.

Most Work Surfaces
Available In:

12" Widths Up To **60"**



24" Lengths Up To **144"**



Butcher Block Overview

- Material: Face-glued hardwood strips
- Finish: Catalyzed clear lacquer, 2 coats top, 1 coat bottom
- Edge: 0.125" radius edge, square or bullnose edge
- Thickness: 1.25", 1.5", 1.75" or 2.25" available
- Sizes: Up to 60"D x 144"L*
- Power: Interchangeable modules for power and media (only fit on certain top options)
- Options: Face-glued maple or hard maple strips, backsplash

*Tops over 36"D are in 2 pieces, field assembled with joint connector bolts.

ShopTop® Overview

- Material: Medium-density fiberboard (MDF) core sandwiched between 0.5" particle board
- Finish: Catalyzed clear lacquer, 2 coats top, 1 coat bottom
- Edge: 0.375" radius edge on long side, 0.125" radius edge
- Thickness: 1.5" or 1.75" available
- Sizes: Up to 60"D x 144"L
- Power: Interchangeable modules for power and media (only fit on certain top options)
- Options: Lumber core, bullnose edge



Hardwood top



Maple top



ShopTop® lumber core (optional)



Field joint hardware for butcher block tops over 36"D





Stainless Steel Top

Leading Provider

Ideal for automotive, industrial and laboratory applications, our stainless steel tops provide a versatile and functional work surface. All stainless steel tops feature welded and polished corners.

resistant

Lab Top

Phenolic Resin & Epoxy Tops

With high resistance to chemicals, humidity and abrasion, our standard 1" thick black phenolic resin or black epoxy tops provide the perfect surface for laboratory work surfaces, shelves and panels.



Most Work Surfaces Available In:

12" Widths Up To **60"**



24" Lengths Up To **144"**



Stainless Steel Top Overview

- Material: 16-gauge 304 stainless steel with particle board core (not suitable for food preparation)
- Finish: #4 finish
- Edge: Wrapped with welded corners
- Thickness: 1.625" thick
- Sizes: Up to 56"D x 144"L in one piece
- Options: Drip edge, T-mold edge, integral backsplash, electrical outlets

Lab Top Overview

- Material: Black phenolic resin or black epoxy
- Finish: Matte finish
- Edge: 0.125" radius edge
- Thickness: 1" thick
- Sizes: Up to 60"D x 144"L
- Power: Interchangeable modules for power and media (only fit on certain top options)
- Options: Backsplash, field machinable



Stainless integrated backsplash with electrical ports (optional)

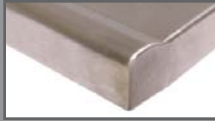

Stainless with drip edge available (optional)



Phenolic backsplash (optional)



Honda, Kenosha, WI



tops

High Pressure Laminate Perfect for Assembly and Packing

Our high pressure laminate tops are easy to clean and resistant to marks, burns, stains, oils and most solvents. High pressure laminate tops are constructed with a phenolic or resin backer sheet to balance the construction and are also available with a chemical resistant or electro-static dissipative surface. Custom laminates available upon request. Call Customer Service for laminate availability.

Most Work Surfaces Available In:

12" Widths Up To **60"**

24" Lengths Up To **144"**



Grounding Kits Available



Standard Laminate Top

- Material: Particle board core with high pressure laminate (HPL) on top, phenolic backer (resin on 1.625" and 1.75")
- Finish: Standard or custom laminates
- Edge: HPL or 0.5mm PVC edge banding, square corners
- Thickness: 0.75", 1.25", 1.625" or 1.75" available
- Sizes: Up to 60"D x 144"L
- Power: Interchangeable modules for power and media (only fit on certain top options)
- Options: Electro-static dissipative or chemical resistant laminate, 1" HPL backslash

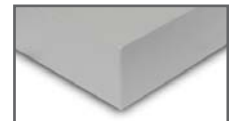

HPL or 0.5mm PVC Edge Banding

Lotz Armor Edge™ Laminate Top

- Material: Medium-density fiberboard (MDF) core with HPL on top, phenolic backer (resin on 1.625")
- Finish: Standard or custom laminates
- Edge: 180° radius or beveled edge with Lotz Armor Edge™, radius corners
- Thickness: 0.75", 1.25" or 1.625" available
- Sizes: Up to 60"D x 144"L
- Power: Interchangeable modules for power and media (only fit on certain top options)
- Options: Colored Lotz Armor Edge™, electro-static dissipative or chemical resistant laminate, 1" HPL backslash



Radius or Beveled edge with Lotz Armor Edge™

3mm Edge Laminate Top

- Material: Particle board core with high pressure laminate (HPL) on top, phenolic backer
- Finish: Standard or custom laminates
- Edge: 3mm PVC edge banding, square or radius corners
- Thickness: 0.75" or 1.25" available
- Sizes: Up to 60"D x 144"L
- Power: Interchangeable modules for power and media (only fit on certain top options)
- Options: Electro-static dissipative or chemical resistant laminate, 1" HPL backsplash, postformed long edge

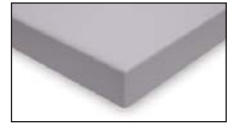

3mm Edge Square or Radius Corner

T-Mold Edge Laminate Top

- Material: Particle board core with high pressure laminate (HPL) on top, phenolic backer
- Finish: Standard or custom laminates
- Edge: T-mold edge banding (black), radius corners
- Thickness: 0.75" or 1.25" available
- Sizes: Up to 60"D x 144"L
- Power: Interchangeable modules for power and media (only fit on certain top options)
- Options: Electro-static dissipative or chemical resistant laminate, 1" HPL backsplash



T-Mold Edge Banding & Radius Corner

Postformed Laminate Top

- Material: Particle board or MDF core (see price book) with HPL on top, phenolic backer (resin on 1.625" and 1.75") (Ergo and Comfort edges have a MDF core)
- Finish: Standard or custom laminates
- Front Edge: 180° Bullnose, Ergo, Comfort or 90° Modern edge wrapped with HPL
- Edge: 0.5mm PVC edge banding
- Thickness: 0.75", 1.25", 1.625" or 1.75" available (Ergo & Comfort edge only available in a 1.25" thickness)
- Sizes: Up to 48"D x 144"L
- Power: Interchangeable modules for power and media (only fit on certain top options)
- Options: Electro-static dissipative or chemical resistant laminate, 1" HPL backsplash



180° Bullnose



Ergo

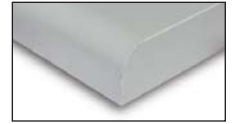

90° Modern



Comfort

HPL Standard Laminate Color Options

(-KA)	(-94)	(-32)	(-209)	(-AA)	(-66)	(-09)	(-25)	(-05)
(-EM)	(-04)	(-03)	(-69)	(-HL)	(-A41)	(-C09)	(-A91)	(-D08)

WB Kensington Maple* WB Fusion Maple* WB Bannister Oak* WB American Cherry* WB Wild Cherry* WB Montana Walnut* WB Black* WB Grey Nebula* WB Dove Grey* WB Khaki Brown* WB Almond* WB White* WB Hollyberry WB Woolamai Brush WB Ocean WB Tangerine WB Basket Weaving WB Eggplant

*Stocked in limited sizes & quantities. Contact Customer Service for lead time.

Complimentary edgeband option for these laminates, matching edgebanding unavailable.



Complete Laminate Collections Available



Kohls Distribution Center, DC



Medford Vet Clinic, WI



Shelving

from WB Manufacturing

Keep your supplies up and out of the way with safe and secure shelving and safety shelving from WB Manufacturing. From the retail floor to the warehouse, over head in the laboratory or on the shop wall, WB Manufacturing offers a complete line of shelving from standard flat panels to safety shelving with stainless steel retaining rods or 2" T-mold edge. Available with chemical resistant laminates and phenolic, WB Manufacturing's shelving can be adapted to any environment. If one of our standard units or kits does not meet your needs, contact Customer Service and let us design, build and deliver a custom solution.





Shelving

Shelving & Safety Shelving

From standard laminate shelving to phenolic safety shelving with retaining rods, WB Manufacturing offers a full line of shelving options to meet all your needs. Available as single shelves or full kits with shelving standards and brackets for a true turn-key solution.



2 - SHLV6033 with KV brackets and standards

shelving it

Safety Shelving Kits Complete Shelving Solutions

Keep your supplies off the counter and safely stored with WB Manufacturing's shelving kits. Ideal for science labs, classrooms and work and prep areas. Kits include 3 or 4, 12" deep, 1" thick shelves in 3', 4' or 5' lengths with heavy duty brackets and standards.



Shelving Overview

Shelving:	1" particle board core with high pressure laminate (HPL) on top and bottom
Edge:	0.5mm PVC, HPL or 3mm PVC
Finish:	Standard or custom laminates
Safety Shelving:	1" particle board core with chemical resistant laminate (CRL) on top, HPL on bottom
Finish:	Standard grey or black
Phenolic:	1" black phenolic resin with 0.125" radius edge
Safety Rods:	0.25" diameter, 1" tall stainless steel rods, fit in pre-drilled holes, field installed
2" T-Mold:	One piece, 2" tall T-mold PVC square edge with micro-mitered corners, black
Options:	Electro-static dissipative laminate

See page 193 for more shelving standards and brackets.



0.25" x 1"H round stainless steel retaining rods



2" T-mold edge creates 1" deep safety tray for containing spills



Heavy duty dual brackets and twin pin standards



HPL Standard Laminate Color Options

(-KA)	(-94)	(-32)	(-209)	(-AA)	(-66)	(-09)	(-25)	(-05)
(-EM)	(-04)	(-03)	(-60)	(-HL)	(-A41)	(-C09)	(-A91)	(-D08)

*Stocked in limited sizes & quantities. Contact Customer Service for lead time.

Complimentary edgeband option for these laminates, matching edgebanding unavailable.

CRL Color Options

(-09)	(-05)
Black	WB Grey

Shelving & Safety Shelving

.020 PVC Edge	HPL Edge	3MM Edge	Retaining Rod	2" T-Mold Edge	Phenolic	Phenolic w/Rods

Shelf sizes available between 12" x 24" to 24" x 72".

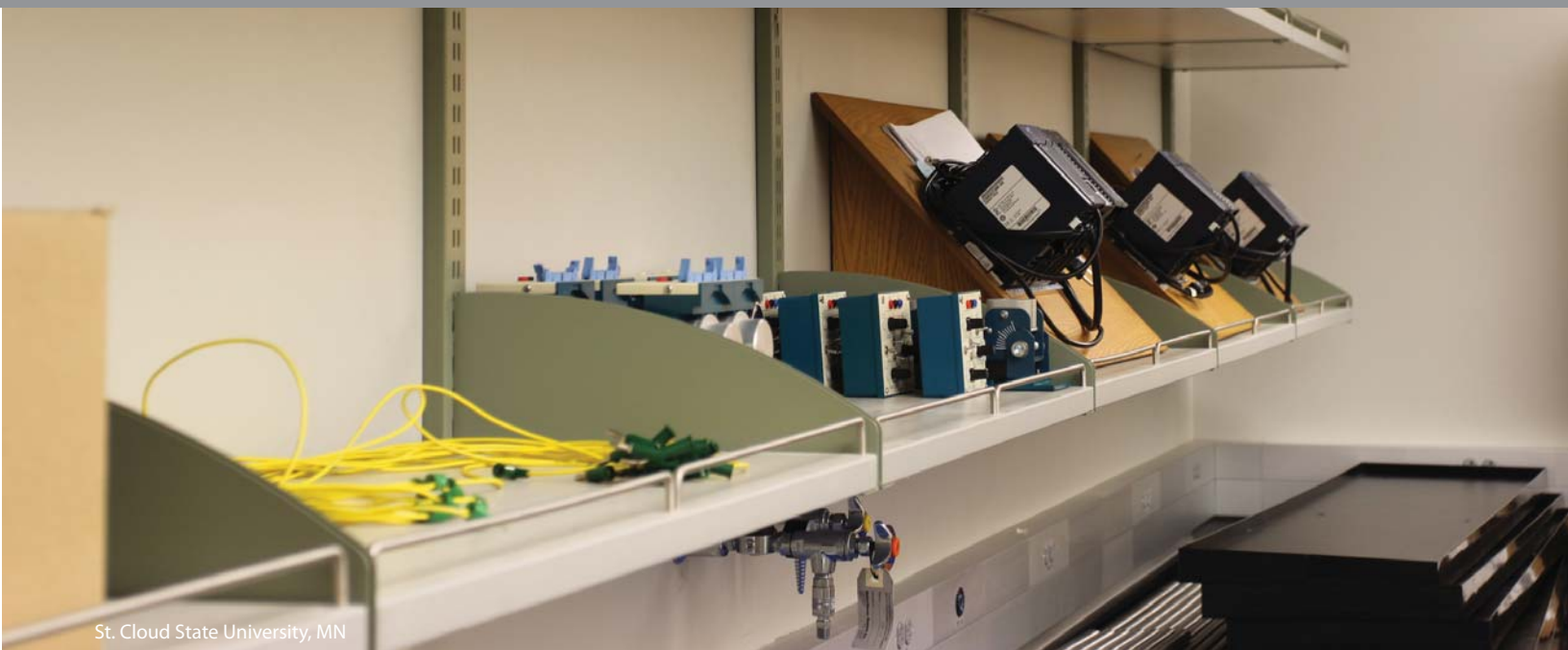

St. Cloud State University, MN



Enova Lockers



Lockers & Locker Benches

from WB Manufacturing

Furnish your employee lounge, locker or visitor's rooms with WB Manufacturing's World Famous Lockers with raised panel, veneer or laminate doors for a serene but classic atmosphere for your country clubs, health clubs, sports stadiums, medical and recreational facilities and universities, or check out our REplay® modular lockers. These stylish and durable lockers solve the most common locker storage requirements for guests, staff and students. No matter what your locker needs, at WB Manufacturing, **We Can.**





Laminate Bench

Have a Seat

Complimentary laminate benches for all your seating needs. Select from three styles: two with our popular 1 1/4" hardwood benchtop for extra durability or a 1" TFL seat, either with an open base or cubbie base to store backpacks or duffle bags up off the floor.

benches

Hardwood Topped Laminate Bench

Functional Flexibility



These are perfect for your sports or fitness complex, educational facility, office, vestibule or breakroom. Choose from any TFL standard laminate base, while enjoying the warmth and longevity of our quality-built hardwood locker benches. The cubbie base is perfect for shoes, backpacks, toys, books or supplies.

Laminate Bench Overview

Frame: Fully doweled double-sided thermal fused laminate (TFL), pocket screwed for re-enforcement

Finish: Standard TFL

Edge Banding: Matching 3mm PVC

Seat: Matching TFL or 1.25" butcher block with radius edge for comfort, 2 coats clear catalyzed lacquer top, 1 coat bottom

Mobility: Screw-in, non-marring glides



Fully doweled TFL frame construction



1" TFL seat



1.25" butcher block seat



Pocket screwed for re-enforcement

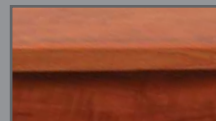

Matching 3mm PVC edge banding

TFL Standard Laminate Color Options

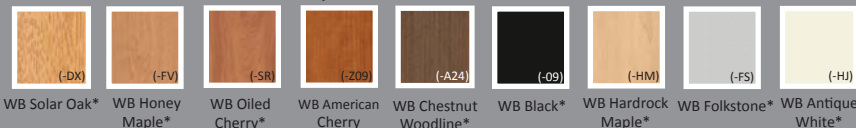

Complete Laminate Collections Available

*Stocked in limited sizes & quantities. Contact Customer Service for lead time.

Laminate Benches

Model#	Description	Model#	Description	DxLxH
LLB1524	Laminate Bench, Laminate Seat	BLLB1524	Laminate Bench, Hardwood Seat	15" x 24" x 18"
LLB1536	Laminate Bench, Laminate Seat	BLLB1536	Laminate Bench, Hardwood Seat	15" x 36" x 18"
LLB1548	Laminate Bench, Laminate Seat	BLLB1548	Laminate Bench, Hardwood Seat	15" x 48" x 18"
LLB2024	Laminate Bench, Laminate Seat	BLLB2024	Laminate Bench, Hardwood Seat	20" x 24" x 18"
LLB2036	Laminate Bench, Laminate Seat	BLLB2036	Laminate Bench, Hardwood Seat	20" x 36" x 18"
LLB2048	Laminate Bench, Laminate Seat	BLLB2048	Laminate Bench, Hardwood Seat	20" x 48" x 18"
LLB2424	Laminate Bench, Laminate Seat	BLLB2424	Laminate Bench, Hardwood Seat	24" x 24" x 18"
LLB2436	Laminate Bench, Laminate Seat	BLLB2436	Laminate Bench, Hardwood Seat	24" x 36" x 18"
LLB2448	Laminate Bench, Laminate Seat	BLLB2448	Laminate Bench, Hardwood Seat	24" x 48" x 18"
LCB1745	3 Cubbie Bench, Laminate Seat	BBCB1745	3 Cubbie Bench, Hardwood Seat	17" x 45.25" x 17"
LCB1760	4 Cubbie Bench, Laminate Seat	BBCB1760	4 Cubbie Bench, Hardwood Seat	17" x 60" x 17"
LCB1775	5 Cubbie Bench, Laminate Seat	BBCB1775	5 Cubbie Bench, Hardwood Seat	17" x 74.75" x 17"



LCB1775



LBS12096
& SSLP



LBSADA2042

Locker Bench

Seats, Kits and ADA

Sturdy enough to support the toughest team yet

accessible enough for people with disabilities.

Our hardwood, phenolic and ADA benches

feature a smooth surface providing a high-quality appearance and easy access. All edges and corners

are radius cut for comfort, safety and a classic look to become an integral part to any seating plan.

benches

Hardwood

The Best in Benches

WB Manufacturing has been building quality hardwood benches and tops for more than 30 years, and our hardwood locker benches are no exception. A quality-constructed, comfortable, durable bench that will last for years to come is ensured by 1 1/4" face-glued hardwood strips with full radius edges and two coats catalyzed lacquer finish. Adapt our hardwood seats to your base, or complete your bench with our pedestals, wall hangers or kits.



LBS24048



LBS12060 - 09060-04

Locker Bench Overview

Wood Seat:	1.25" face-glued hardwood strips
Wood Finish:	2 coats clear catalyzed lacquer top and edges, 1 coat bottom
Wood Edge:	Radius comfort edge and rounded corners
Phenolic Seat:	1" matte black phenolic resin
Phenolic Edge:	Eased edge and rounded corners
Pedestals:	16.25" tall round or trapezoid in stainless steel or almond, 17.75" tall U-Frame in black (sold separately)



Round Pedestals available in Stainless Steel & Almond



Pedestals attach via 8" round integrated plate and screws*



Trapezoid Pedestals available in Stainless Steel and Almond



U-Frame Pedestals available in Black



Wall mount brackets available in Black, Almond and Stainless



Catalyzed clear lacquer finish

Hardwood Locker Bench Seats

9.5" Depth	12" Depth	*15" Depth	18" Depth	24" Depth	Seat Length
LBS9H024	LBS12024	LBS15024	LBS18024	LBS24024	24"
LBS9H036	LBS12036	LBS15036	LBS18036	LBS24025	36"
LBS9H042	LBS12042	LBS15042	LBS18042	LBS24042	42"
LBS9H048	LBS12048	LBS15048	LBS18048	LBS24048	48"
LBS9H060	LBS12060	LBS15060	LBS18060	LBS24060	60"
LBS9H072	LBS12072	LBS15072	LBS18072	LBS24072	72"
LBS9H084	LBS12084	LBS15084	LBS18084	LBS24084	84"
LBS9H096	LBS12096	LBS15096	LBS18096	LBS24096	96"
LBS9H108	LBS12108	LBS15108	LBS18108	LBS24108	108"
LBS9H120	LBS12120	LBS15120	LBS18120	LBS24120	120"
LBS9H132	LBS12132	LBS15132	LBS18132	LBS24132	132"
LBS9H144	LBS12144	LBS15144	LBS18144	LBS24144	144"

Note: Hardwood locker benches are not recommended for areas with high moisture content. *Custom pricing.

Locker Bench Pedestals* (Sold Separately)

Model#	Description
MSLP	16.25"H Round, Almond
SSLP	16.25"H Round, Stainless Steel
09060	16.25"H Trapezoid, Stainless Steel
09060-04	16.25"H Trapezoid, Almond
6773	17.75"H U-Frame, Black

ADA Hardwood Locker Bench Seats

20" Depth	24" Depth	Seat Length
LBS20042	LBS24042	42"
LBS20048	LBS24048	48"



We Can.

DESIGN. BUILD. DELIVER.

Need a size you don't see listed? WB Manufacturing can build locker benches to your specifications. For more information, contact our Customer Service Team at 800.242.2303.



LBS24048 & SSLP

Locker Bench Wall Brackets

Model#	Description (sold in pairs)
BKT0508	9.5"D and 12"D seat Almond (-A) Black (-B)
BKT0812	15"D seat Almond (-A) Black (-B)
BKT1218	20"D seat Almond (-A) Black (-B) Stainless Steel (-SS)
BKT1521	24"D seat Almond (-A) Black (-B) Stainless Steel (-SS)

*It is recommended to install two pairs of round pedestals for every four foot span on ADA benches. It is recommended to install two pedestals for every four foot span on locker benches. Hardware to attach pedestal to the bench is included. NOTE: It is recommended to attach pedestals to the floor. Hardware to attach pedestals to floor is not included.

Hardwood Locker Bench Kits

<i>Almond Pedestal</i>	<i>Stainless Pedestal</i>	<i>Description</i>	<i>DxL</i>
LBSMP9H048	LBSMP9H048SS	Hardwood Seat with 2 Pedestals*	9.5" x 48"
LBSMP9H060	LBSMP9H060SS	Hardwood Seat with 2 Pedestals*	9.5" x 60"
LBSMP9H072	LBSMP9H072SS	Hardwood Seat with 2 Pedestals*	9.5" x 72"
LBSMP9H096	LBSMP9H096SS	Hardwood Seat with 3 Pedestals*	9.5" x 96"
LBSMP12048	LBSMP12048SS	Hardwood Seat with 2 Pedestals*	12" x 48"
LBSMP12060	LBSMP12060SS	Hardwood Seat with 2 Pedestals*	12" x 60"
LBSMP12072	LBSMP12072SS	Hardwood Seat with 2 Pedestals*	12" x 72"
LBSMP12096	LBSMP12096SS	Hardwood Seat with 3 Pedestals*	12" x 96"



LBSMP12060

Portable Hardwood Locker Benches

<i>Model#</i>	<i>Description</i>	<i>DxL</i>
LBSMP12048U	Hardwood Seat with 2 Black U Legs, Glides**	12" x 48"
LBSMP12060U	Hardwood Seat with 2 Black U Legs, Glides**	12" x 60"
LBSMP12072U	Hardwood Seat with 2 Black U Legs, Glides (stretcher)**	12" x 72"
LBSMP12096U	Hardwood Seat with 3 Black U Legs, Glides**	12" x 96"
LBSMP15048U	Hardwood Seat with 2 Black U Legs, Glides**	15" x 48"
LBSMP15060U	Hardwood Seat with 2 Black U Legs, Glides**	15" x 60"
LBSMP15072U	Hardwood Seat with 2 Black U Legs, Glides (stretcher)**	15" x 72"
LBSMP15096U	Hardwood Seat with 3 Black U Legs, Glides**	15" x 96"
LBSMP18048U	Hardwood Seat with 2 Black U Legs, Glides**	18" x 48"
LBSMP18060U	Hardwood Seat with 2 Black U Legs, Glides**	18" x 60"
LBSMP18072U	Hardwood Seat with 2 Black U Legs, Glides (stretcher)**	18" x 72"
LBSMP18096U	Hardwood Seat with 3 Black U Legs, Glides**	18" x 96"



LBSMP18048U

Phenolic Locker Bench Kits

<i>Model#</i>	<i>Description</i>	<i>DxL</i>
PLB12048	Phenolic Seat with 2 SSLP Pedestals*	12" x 48"
PLB12072	Phenolic Seat with 3 SSLP Pedestals*	12" x 72"
PLB12096	Phenolic Seat with 3 SSLP Pedestals*	12" x 96"
PLB12120	Phenolic Seat with 4 SSLP Pedestals*	12" x 120"



See our website for a complete Phenolic Bench listing.

PLB12060

ADA Locker Bench Kits with Pedestals and Backs

<i>Almond</i>	<i>Stainless</i>	<i>Description</i>	<i>DxL</i>
LBSADA2042	LBSADA2042SS	ADA Kit with Back (2 piece)*	20" x 42"
LBSADA2048	LBSADA2048SS	ADA Kit with Back (2 piece)*	20" x 48"
LBSADA2060	LBSADA2060SS	ADA Kit with Back (2 piece)*	20" x 60"
LBSADA2072	LBSADA2072SS	ADA Kit with Back (3Frames)(2 piece)*	20" x 72"
LBSADA2442	LBSADA2442SS	ADA Kit with Back (2 piece)*	24" x 42"
LBSADA2448	LBSADA2448SS	ADA Kit with Back (2 piece)*	24" x 48"
LBSADA2460	LBSADA2460SS	ADA Kit with Back (2 piece)*	24" x 60"
LBSADA2472	LBSADA2472SS	ADA Kit with Back (3 Frames)(2 piece)*	24" x 72"



LDSADA2048SS

*Seats are pre-drilled and include hardware to attach bench to pedestal.
 **Seats are pre-drilled and include hardware to attach bench to legs.
 NOTE: Hardware to attach pedestals to floor is not included.



Federal ADA Regulation
Compliant Benches



Wisconsin Bench, WI



Team Locker

Play Hard

Our aesthetically pleasing lockers deliver functionality to your athletic program. Constructed with 3/4", 45 lb. density industrial grade particle board core with choice of laminates or wood veneer.

Infinite choice of finishes and configurations to match your facility's need.



player

Locker, Lockers and More

Update your Athletic Facility

We know every team lineup is different, so we have created a baseline of locker options that are completely customizable to meet your player and facility needs. Let WB Manufacturing outfit your entire locker room with a solution that fits your space and budget. For more information, contact our Customer Service Team at 800.242.2303.



Team Locker Overview

HPL Case: Fully doweled 0.75" high pressure laminate (HPL), full subtop and inset back

Doors: 0.75" 45 lb. density industrial grade particle board core in HPL

Shelves: 0.75" HPL, fully doweled

Finish: Decorative HPL on door and drawers, finished ends and exposed interiors; white TFL on drawer boxes and unfinished ends

Edge Banding: 3mm PVC on doors, drawers, and edge banding

Wood Case: Fully doweled 0.75" MDF with wood veneer on both sides, full subtop and inset back, .040" wood edge banding

Wood Doors: 0.75" thick MDF core with wood veneer on both sides, 3mm wood edge banding

Shelves: 0.75" MDF with wood veneer, fully doweled

Wood Finish: Choice of wood species and UV clear coat

Edge Banding: .040" wood edge banding

Hinges: 6-point adjustable concealed hinge

Base: 0.75" exterior grade plywood ladder or applied base (vinyl base not included)



3mm PVC edge banding



Chrome garment rod



Chrome garment hooks



1" thick HPL seat over vented storage



Seat has piano hinge and soft close support



Wire pulls and integrated locks

HPL Standard Laminate Color Options

WB Kensington Maple*	WB Fusion Maple*	WB Bannister Oak*	WB American Cherry*	WB Wild Cherry*	WB Montana Walnut*	WB Black*	WB Grey Nebula*	WB Dove Grey*
WB Khaki Brown*	WB Almond*	WB White*	WB Hollyberry	WB Woolamai Brush	WB Ocean	WB Tangerine	WB Basket Weaving	WB Eggplant

*Stocked in limited sizes & quantities. Contact Customer Service for lead time.

Complimentary edgeband option for these laminates, matching edgebanding unavailable.

Wood Veneer Species (clear UV finish)

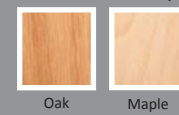

Oak Maple



Complete Laminate Collections Available



Storm Chasers Locker Room, NE



Lockers

Locker Room Solutions

Our aesthetically pleasing, quality-built lockers deliver functionality for students, staff, visitors and employees.

Constructed with 3/4", 45 lb. density industrial grade particle board core with white melamine on both faces and choice of 3/4" laminate and flat or raised wood panel doors. Infinite choices of finishes and configurations are available to match your facility's existing finishes. Ten year warranty.



famous

Towel Drop and Table

Everything For Your Locker Room

Whether a professional basketball team, the local fire department or high school state champs, World Famous Lockers from WB Manufacturing provide more than just the lockers for your facility. From massage tables to taping stations, towel drops and equipment storage, **We Can** provide a customized solution to meet your needs. For more information or to work with our Design Team, contact Customer Service at 800.242.2303.



World Famous Locker Overview

- Case: Fully doweled 0.75" high pressure laminate (HPL), full subtop and inset back
- Doors: 0.75" 45 lb. density industrial grade particle board core in HPL or A-1 wood veneer
- Wood Doors: 0.75" thick x 2.25" wide solid wood frame with solid wood or veneer panel, square raised with radius edge (other styles available)
- Hinges: 6-point adjustable concealed hinge
- Shelves: 0.75" TFL fully doweled
- Finish: Decorative HPL on door and drawer fronts, finished ends and exposed interiors; white TFL on drawer boxes, unfinished ends and interiors
- Wood Finish: Choice of wood and clear coat
- Edge Banding: 0.5mm PVC edge banding, 3mm PVC on doors
- Base: 0.75" exterior grade plywood ladder or applied base (vinyl base not included)



Standard keyed deadbolt (Pull required with this lock)



Knob pull (option)



Contemporary pulls (option)



Recessed pull (option)



Cam padlock hasp (optional with or w/o pull)



Number plates (optional round or rectangular)



Keyed combination lock (optional)



Zephyr Electronic Lock** (optional)



6-point adjustable hinge (standard)



Built in door vent (standard)



Garment rod (optional)



Coat hook (2 standard on 1, 2, 3 & Z)

HPL Standard Laminate Color Options



Wood/Raised Panel Species

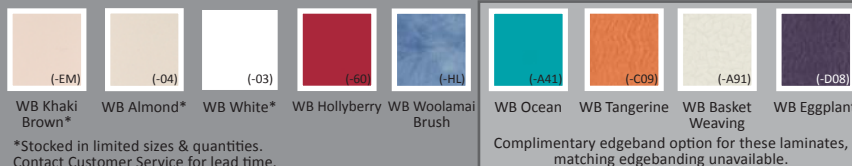
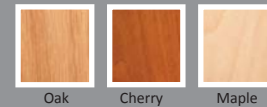

Complete Laminate Collections Available

*Stocked in limited sizes & quantities. Contact Customer Service for lead time.

**ADA locks available upon request. Contact Customer Service for availability.



2DZL-Double Z



Motorola, IL

World Famous Lockers

Model #
1T - 1 Tier



W: 12, 15, 18, 21, 24"
H: 48, 60, 72, 84"
D: 12, 15, 18, 21, 24"
1 Compartment
each with: Shelf, Door,
Right European
Hinge, 2 Coat Hooks

Model #
2T - 2 Tier



W: 12, 15, 18, 21, 24"
H: 48, 60, 72, 84"
D: 12, 15, 18, 21, 24"
2 Compartments
each with: Door,
Right European
Hinge, 2 Coat Hooks

Model #
3T - 3 Tier



W: 12, 15, 18, 21, 24"
H: 48, 60, 72, 84"
D: 12, 15, 18, 21, 24"
3 Compartments
each with: Door,
Right European
Hinge, 2 Coat Hooks

Model #
4T - 4 Tier

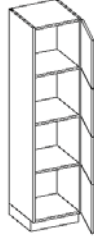

W: 12, 15, 18, 21, 24"
H: 48, 60, 72, 84"
D: 12, 15, 18, 21, 24"
4 Compartments
each with: Door,
Right European
Hinge

Model #
5T - 5 Tier



W: 12, 15, 18, 21, 24"
H: 48, 60, 72, 84"
D: 12, 15, 18, 21, 24"
5 Compartments
each with: Door,
Right European
Hinge

Model #
6T - 6 Tier



W: 12, 15, 18, 21, 24"
H: 48, 60, 72, 84"
D: 12, 15, 18, 21, 24"
6 Compartments
each with: Door,
Right European
Hinge

Model #
2DZL - Double Z

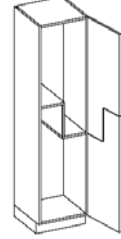

W: 12, 15, 18, 21, 24"
H: 48, 60, 72, 84"
D: 12, 15, 18, 21, 24"
2 Compartments
each with: Door,
Right European
Hinge, 2 Coat Hooks
(Available in laminate
doors only)

Finishing Panels

Model # CF

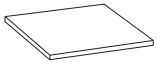

W: 12, 15, 18, 21, 24"
H: 48, 60, 72, 84"
D: 12, 15, 18, 21, 24"
Corner Filler, White
Melamine, Raw
Edges, Field Assembly
Required

Model # KT



W: 12, 15, 18, 21, 24"
H: 48, 60, 72, 84"
D: 12, 15, 18, 21, 24"
Kick Trim, Raw Edges,
One Face is Finished,
Field Cutting Required

Model # ST

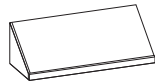

W: 12 to 48"
(3" increments)
H: As Needed
D: As Needed
Sloped Top, 1.75"
Front Face, Vertical
Wood Grain (flat
panel with horizontal grain
available upon request)

Model # FL



W: 3, 6, 12, 24"
H: 96"
D: 0.75"
Filler Panel, Finished
on Short Edges and
One Face Field
Cutting Required

Model # FEP



W: 0.75"
H: As Needed
D: As Needed
Finished End Panel,
Finished on One Face
and 3 Edges

Model # ULB

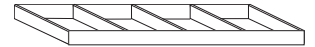

W: 96"
H: 4, 6"
D: Based on locker depth
Plywood Ladder Base,
Unfinished Plywood Strips
Field Assembled
Covers 8 Linear Feet

Locker Configurations

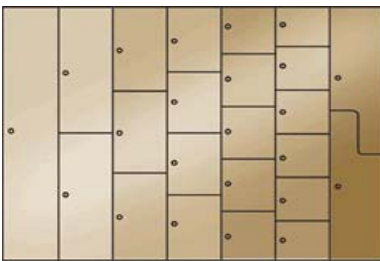

Available in 1-6 doors
or 2-door Z.
Customization available.
(Z door available in laminate only).

Panel Options



Laminate



Wood Veneer



Wood Flat Panel



Wood Raised Panel

Additional Accessories

- 5" x 7" Mirror
- Fixed Shelf
- Name Plate Holders
- Drawer With Lock
- Drawer Without Lock
- Adjustable Shelf
- Shoe Shelf Cubbies
- 4" Kick Trim
- Lock Box Unit

Complete your install
with standard or
custom casework from
WB Manufacturing.
See pages 158-181.



Elgin Country Club, IL



Fitness Center



Repositionable Laminate Locker

Flexible Storage

Constructed using the same standards as our REplay® cabinets, our laminate lockers can go anywhere at any time.

Laminate lockers include fully finished back and toe kick, allowing for easy installation and leaving floors and walls untouched while providing safe, secure storage for your clients. Lockers ship fully assembled.



lock-em

Repositionable Laminate Locker Groups

One Wall, One SKU

Furnish your employee lounge, classroom, locker room or visitor's room with WB Manufacturing's REplay® pre-configured modular locker groups. Fully doweled, thermal fused laminate construction with adjustable corner levelers make these the most versatile repositionable lockers on the market, now available as a complete group of lockers with just one SKU. Twelve pre-configured solutions to solve the most common locker storage requirements or a variety of groups for a semi-custom solution.



REplay® Laminate Locker Overview

- Case: Fully doweled 0.75" double-sided thermal fused laminate (TFL) with matching top over 0.75" subtop
- Doors: 0.75" double-sided TFL
- Hinges: 6-point adjustable concealed hinge
- Locks: Standard deadbolt lock and knob pull
- Shelves: 0.75" TFL fully doweled
- Finish: Standard TFL colors
- Edge Banding: 0.5mm PVC edge banding, 3mm PVC on doors
- Base: Integrated fully finished base with built-in levelers

Note: Number plates and other lock and pull options are available.
Laminate lockers and groups can be outfitted with locker accessories shown below. Additional costs may apply.



0.75" fully doweled TFL casebody construction



Fully finished back and toe kick



Built-in levelers (standard)



6-point adjustable hinge (standard)



Standard deadbolt lock and knob pull



Contemporary pulls (option)



Keyed combination lock (optional)



Zephyr Electronic Lock (optional)



Recessed pull (optional)



Cam padlock hasp (optional with or w/o pull)



Number plates (optional round or rectangular)

TFL Standard Laminate Color Options

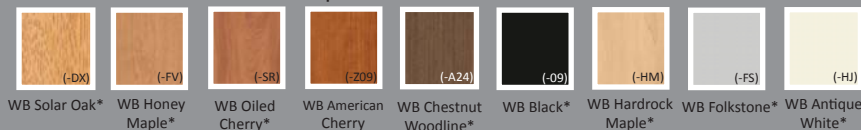

WB Solar Oak* WB Honey Maple* WB Oiled Cherry* WB American Cherry WB Chestnut Woodline* WB Black* WB Hardrock Maple* WB Folkstone* WB Antique White*



Complete Laminate Collections Available



*Stocked in limited sizes & quantities. Contact Customer Service for lead time.
**ADA locks available upon request. Contact Customer Service for availability.



Colstrip High School, MT

Laminate Lockers & Locker Groups

Model # 1TFL



Model # 2TFL



Model # 3TFL

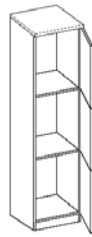

Model # 5TFL



W: 15"
H: 60 or 72"
D: 18"

1 Compartment with: Door,
Shelf, Right European Hinge
2 Coat Hooks

W: 15"
H: 60 or 72"
D: 18"

2 compartments each with:
Door, Right European Hinge
2 Coat Hooks

W: 15"
H: 72"
D: 18"

3 compartments each with:
Door, Right European Hinge
2 Coat Hooks

W: 15"
H: 72"
D: 18"

5 compartments each with:
Door, Right European Hinge



Model #	Description	WxHxD*
1TFLGP6-72	1TFL Locker, 6 Units, 6 Compartments	90" x 72" x 18"
1TFLGP8-72	1TFL Locker, 8 Units, 8 Compartments	120" x 72" x 18"
1TFLGP10-72	1TFL Locker, 10 Units, 10 Compartments	150" x 72" x 18"
2TFLGP6-72	2TFL Locker, 6 Units, 12 Compartments	90" x 72" x 18"
2TFLGP8-72	2TFL Locker, 8 Units, 16 Compartments	120" x 72" x 18"
2TFLGP10-72	2TFL Locker, 10 Units, 20 Compartments	150" x 72" x 18"
3TFLGP6-72	3TFL Locker, 6 Units, 18 Compartments	90" x 72" x 18"
3TFLGP8-72	3TFL Locker, 8 Units, 24 Compartments	120" x 72" x 18"
3TFLGP10-72	3TFL Locker, 10 Units, 30 Compartments	150" x 72" x 18"
5TFLGP6-72	5TFL Locker, 6 Units, 30 Compartments	90" x 72" x 18"
5TFLGP8-72	5TFL Locker, 8 Units, 40 Compartments	120" x 72" x 18"
5TFLGP10-72	5TFL Locker, 10 Units, 50 Compartments	150" x 72" x 18"

*Width based on 15" locker width multiplied by number of lockers in group.

Get all your custom locker needs from WB Manufacturing, should you be looking for specialty lockers for digital code access, cell phone or tablet storage at testing or government facilities, client mailboxes... the options are endless. Let WB Manufacturing design, build and deliver your next set of custom lockers. For more information, contact our Customer Service Team at 800.242.2303.



*Installation of digital coding devices are not included.

We Can.

DESIGN. BUILD. DELIVER.



YWCA Uptown Minneapolis, MN

When the bid went out for a quote on custom, budget-minded lockers for the YWCA Uptown, the contractor contacted WB Manufacturing. World Famous Lockers provided high end, quality lockers at a price point that couldn't be beat. Let WB Manufacturing design, build and deliver your next locker room.



Wall Cubbies

Space-Savers

Space-saving wall cubbies, constructed of 3/4" particle core board or double-sided thermal fused laminate, from WB Manufacturing keep garments off the floor and materials tucked away. Select from two styles and three standard lengths to fit most spaces. To add to your space and cubbie usage possibilities, consider adding a 1" steel rod bottom shelf.

Custom wall hung 48"TCB02 shown in bannister oak, customized height with no base panel, optional steel rod shelf and three single prong hooks per compartment; wall mounted.

Tall Cubbies

Extra Storage

Solve your clutter and additional storage needs for the classroom, employee lounge or staff areas with tall cubbies from WB Manufacturing. Standard and custom cubbies are available to meet all your storage needs.

WB Manufacturing can customize any of our cubbies to meet your needs! To learn of the possible custom design options, contact our Customer Service Team at 800.242.2303.



24"TCB02 shown with optional ladder base.

Cubbies Overview

Material: Fully doweled 0.75" particle board core with high pressure laminate on both sides or 0.75" double-sided thermal fused laminate

Finish: Standard HPL or TFL

Edge Banding: Matching 3mm PVC

End Panels: Square or contoured (BH)

Hooks: One single- or double-prong hook below each compartment

Steel Rod: 1" steel rod bottom shelf (optional)



3mm PVC edge banding



Double-prong garment hooks



Single-prong garment hooks

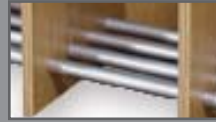

1" steel rod bottom shelf (optional)



TFL Standard Laminate Color Options



WB Solar Oak*



WB Honey Maple*



WB Oiled Cherry*



WB American Cherry



WB Chestnut Woodline*



WB Black*



WB Hardrock Maple*



WB Folkstone*



WB Antique White*



Complete Laminate Collections Available

*Stocked in limited sizes & quantities. Contact Customer Service for lead time.



Grantline School, IN

Before

After

Wall Cubbies

Model #

WCB2583/84/85

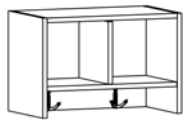

Model #

WCB2583/84/85 - BH

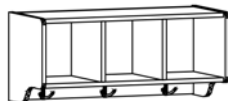

Tall Cubbies

Model # TCB01

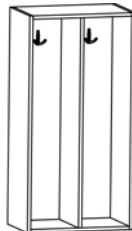

Model # TCB02

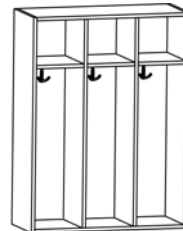

Model # TCB03

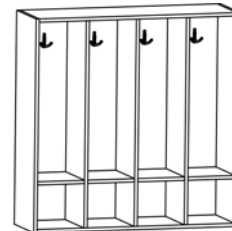

Model # TCB04

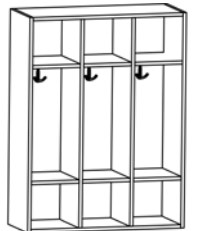

W: 24", 36" or 48"

H: 16"

D: 14"

Open, Square Ends

24"W, 2 Compts.(shown)

36"W, 3 Compts.

48"W, 4 Compts.

W: 24", 36" or 48"

H: 16"

D: 14"

Open, Contoured Ends

24"W, 2 Compts.

36"W, 3 Compts.(shown)

48"W, 4 Compts.

W: 24, 36 or 48"

H: 48, 60 or 72"

D: 14"

Open

24"W, 2 Compts.(shown)

36"W, 3 Compts.

48"W, 4 Compts.

W: 24, 36 or 48"

H: 48, 60 or 72"

D: 14"

Open, Fixed Top Shelf

24"W, 2 Compts.

36"W, 3 Compts.(shown)

48"W, 4 Compts.

W: 24, 36 or 48"

H: 48, 60 or 72"

D: 14"

Open, Fixed Bottom Shelf

24"W, 2 Compts.

36"W, 3 Compts.

48"W, 4 Compts.(shown)

W: 24, 36 or 48"

H: 48, 60 or 72"

D: 14"

Open, Fixed Top & Bottom Shelves

24"W, 2 Compts.

36"W, 3 Compts.(shown)

48"W, 4 Compts.



Alexandria High School, MN



Seating

from WB Manufacturing

From the art room to the shop floor, WB Manufacturing's stools are the strongest, most stable stools on the market. Featuring hardwood and Lotz Armor Edge™ laminate seats attached to a fully welded frame, our stools are virtually indestructible. If strength isn't enough, WB also offers a five-legged stool to keep students and employees safe from accidental tip overs. WB stools are available in powder coated, square tube or chrome round tube steel. We've never actually tried it, but we would like to think you could park an elephant on our stools.





STL7186-AP

5-Legged Stool

The Industry's Best Stool

Our five-legged fully welded, 16-gauge steel frame stools offer the best stability available and can virtually eliminate students from leaning back on two legs. Powder coated texture frame is available in several sizes in fixed or adjustable heights and solid steel foot ring is MIG welded to frame.



The Most Durable
5-Legged Stool
on the Market.



STL9186-AR-BZ

stools

4-Legged Stool

Fully Welded Square Tube

Our four-legged stools adhere to the same high construction standards as our five-legged stools. Available in fixed or adjustable heights with and without backrest. Choice of hardwood, laminate or urethane seat with indestructible Lotz Armor Edge™.



STL7186-AQ



STL7186-BW



STLUR186-AM-BZ

Square Tube Stool Overview

Frame: 16-gauge heavy duty 1.25" (adjustable) and 1" (fixed) steel tube legs fully welded to 12-gauge seat mounting plate

Finish: Textured black powder coating

HWS Seat: 14" round 1.25" face-glued hardwood strips, radius edge, 2 coats catalyzed lacquer finish (-HW)

AE Seat: 14" round 1.25" high pressure laminate (HPL), radius Lotz Armor Edge™ and phenolic backer (-AE)

Urethane Seat: 14" round 1.75" Urethane Seat (-UR)

Backrest: 16-gauge tubular steel, textured black finish only (available as 4 legged stool only), optional bolt-on backrest (-BZ)

Footrest: 0.375" diameter ring, fully welded to legs

Glides: Non-marring glides



Footrest ring welded to legs



Legs are fully welded to 12-gauge seat plate



Hardwood seat with radius edge and two coats clear catalyzed lacquer finish

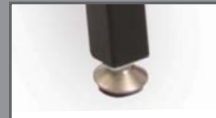

Non-marring glides



Adjustable legs adjust in 1" increments



Laminate seat with Lotz Armor Edge™ or our hardwood face-glued seats

HPL Standard Laminate Top Color Options with Lotz Armor Edge™

WB Kensington Maple*	WB Fusion Maple*	WB Bannister Oak*	WB American Cherry*	WB Wild Cherry*	WB Montana Walnut*	WB Black*	WB Grey Nebula*	WB Dove Grey*
WB Khaki Brown*	WB Almond*	WB White*	WB Hollyberry	WB Woolamai Brush	WB Ocean	WB Tangerine	WB Basket Weaving	WB Eggplant

*Stocked in limited sizes & quantities. Contact Customer Service for lead time.

Complimentary edgeband option for these laminates, matching edgebanding unavailable.

Frame Color Options

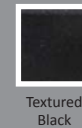

Textured Black



Urethane seat



Alexandria High School, MN

Square Tube Fully Welded Stools

4-Legged Stool - No Backrest

Laminate with

Lotz Armor Edge™	Hardwood Seat	Urethane Seat	Description	Seat Height*
STL7186-AF	STL9186-AF	STLUR186-AF	Desk Height Fixed Stool	18"
STL7186-AJ	STL9186-AJ	STLUR186-AJ	Counter Height Fixed Stool	24"
STL7186-AQ	STL9186-AQ	STLUR186-AQ	Table Height Adjustable Stool	18"-28"
STL7186-AM	STL9186-AM	STLUR186-AM	Counter Height Adjustable Stool	22"-32"

4-Legged Stool - Bolt-On Backrest

Laminate with

Lotz Armor Edge™	Hardwood Seat	Urethane Seat	Description	Seat Height*
STL7186-AF-BZ	STL9186-AF-BZ	STLUR186-AF-BZ	Desk Height Fixed Stool with Backrest	18"
STL7186-AJ-BZ	STL9186-AJ-BZ	STLUR186-AJ-BZ	Counter Height Fixed Stool with Backrest	24"
STL7186-AQ-BZ	STL9186-AQ-BZ	STLUR186-AQ-BZ	Table Height Adjustable Stool with Backrest	18"-28"
STL7186-AM-BZ	STL9186-AM-BZ	STLUR186-AM-BZ	Counter Height Adjustable Stool with Backrest	22"-32"

4-Legged Stool - Welded-On Backrest

Laminate with

Lotz Armor Edge™	Hardwood Seat	Urethane Seat	Description	Seat Height*
STL7186-BX	STL9186-BX	STLUR186-BX	Counter Height Fixed Stool with Backrest	24"
STL7186-BV	STL9186-BV	STLUR186-BV	Table Height Adjustable Stool with Backrest	18"-28"
STL7186-BW	STL9186-BW	STLUR186-BW	Counter Height Adjustable Stool with Backrest	22"-32"

5-Legged Stool - No Backrest

Laminate with

Lotz Armor Edge™	Hardwood Seat	Urethane Seat	Description	Seat Height*
STL7186-AH	STL9186-AH	STLUR186-AH	Desk Height Fixed Stool	18"
STL7186-AL	STL9186-AL	STLUR186-AL	Counter Height Fixed Stool	24"
STL7186-AR	STL9186-AR	STLUR186-AR	Table Height Adjustable Stool	18"-28"
STL7186-AP	STL9186-AP	STLUR186-AP	Counter Height Adjustable Stool	22"-32"

5-Legged Stool - Bolt-On Backrest

Laminate with

Lotz Armor Edge™	Hardwood Seat	Urethane Seat	Description	Seat Height*
STL7186-AH-BZ	STL9186-AH-BZ	STLUR186-AH-BZ	Desk Height Fixed Stool with Backrest	18"
STL7186-AL-BZ	STL9186-AL-BZ	STLUR186-AL-BZ	Counter Height Fixed Stool with Backrest	24"
STL7186-AR-BZ	STL9186-AR-BZ	STLUR186-AR-BZ	Table Height Adjustable Stool with Backrest	18"-28"
STL7186-AP-BZ	STL9186-AP-BZ	STLUR186-AP-BZ	Counter Height Adjustable Stool with Backrest	22"-32"

*Seat height increases .5" with an urethane seat.



W318-HW

Chrome Tube Stool

Round Seat, Round Tube

These chrome stools are built to last with a fully welded frame; no screws to replace or retighten. Our hard plastic seat is durable and will hold up under rigorous daily use. Or, choose a hardwood seat with radius comfort edge for the look of natural wood. Finally, our laminate seat is the most versatile of the seat options, with numerous laminate color choices. When combined with our Lotz Armor Edge™, the laminate seat outlasts virtually any other stool on the market. Stools are available in fixed and adjustable heights, with and without backrests. Comfortable, stylish seating for the art room, science lab, computer lab or anywhere durable, comfortable seating is required. Non-marring glides won't scratch floors.



W318

chrome



W318SSA

Chrome Tube Stool

Hard Plastic Seat and Back

Our fully welded chrome stools are built to last and look great for years. A waterfall front edge on the square seats and curved comfort backs feature smooth molded fire resistant hard plastic with permanent color throughout and are resistant to stains and wear. No screws to tighten on fully welded stool foot ring.



W324NSS

Chrome Tube Stool Overview

- Frame: Fully welded, 18-gauge 1" steel tube legs, adjustable inserts (on adjustable stools)
- Finish: Nickel chrome plating
- Plastic Seat: 13" round 0.625" hard plastic or 16" square 0.625" hard plastic 2 piece seat with back, swivel on certain models
- HWSeat: 14" round 1.25" face-glued hardwood strips, radius edge, 2 coats catalyzed lacquer finish (-HW)
- AE Seat: 14" round 1.25" high pressure laminate (HPL), radius Lotz Armor Edge™ and phenolic backer (-AE)
- Urethane Seat: 14" round 1.75" Urethane Seat (-UR)
- Glides: Non-marring glides, nylon or steel



Non-marring glides are perfect for any flooring



Hard plastic seats are solid for superior strength



Hardwood seat with radius edge and two coats clear catalyzed lacquer finish (-HW)



Swivel seat stools provide versatility for many applications



Steel frame is fully welded for extra rigidity and strength



Adjust leg height easily with dual button screw and allen wrench, 1" increments

Hard Plastic Back & Square Seat Color Options



Black Navy Burgundy Emerald Charcoal Lt. Grey* Sand* Royal Cranberry Fusion Maple* Golden Oak* Walnut

Round Seat Color Options



Black* Navy* Burgundy* Sand Hardwood Urethane

*Stocked Hard Plastic Colors

Fixed Chrome Tube Fully Welded Stools

Laminate with

<i>Hard Plastic Seat</i>	<i>Lotz Armor Edge™</i>	<i>Hardwood Seat</i>	<i>Urethane Seat</i>	<i>Description</i>	<i>Seat Height*</i>
W318	W318AE	W318HW	W318UR	Round Seat	18"
W318SS				Square Swivel Seat w/Back	20"
W324	W324AE	W324HW	W324UR	Round Seat	24"
W324NSS				Square Seat w/Back	25"
W324SS				Square Swivel Seat w/Back	26"

Adjustable Chrome Tube Fully Welded Stools

Laminate with

<i>Hard Plastic Seat</i>	<i>Lotz Armor Edge™</i>	<i>Hardwood Seat</i>	<i>Urethane Seat</i>	<i>Description</i>	<i>Seat Height*</i>
W318A	W318AAE	W318AHW	W318AUR	Round Seat	18-28"
W318SSA				Square Swivel Seat w/Back	20.5-30"
W324A	W324AAE	W324AHW	W324AUR	Round Seat	22-32"
W324SSA				Square Swivel Seat w/Back	24"-34"

*Seat height increases .5" with an urethane seat.



non-marring



steel



nylon

Task Chair

Adjustable Mobile Seating

The Task Chair is an excellent addition to your classroom or computer lab. Available with a two-piece hard plastic seat. Roll the task chair anywhere on dual-wheel casters or select optional bell glides. Easy hydraulic adjustment seat height from 15"-21" with the lift of a handle.



task

Task Chair Overview

Frame: 12-gauge heavy duty steel plate, 14-gauge 1" steel tube for chairs with hard plastic seat and back

Seats: Hard plastic 2 piece seat and back

Base: Five-prong black nylon base with five 50mm twin wheel casters, hydraulic shaft

Optional: Nylon bell glides (-BG)

1 Pc. Soft Plastic Seat Color Options

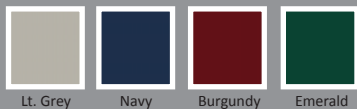

Hard Plastic Back & Square Seat Color Options



*Stocked Hard Plastic Colors

Task Chairs

Model # Description

Seat Height

750 Adjustable Height Task Chair w/2 piece Hard Plastic Seat/Back

15"-21"



Sturdy 5-prong base and hydraulic shaft



Standard 50mm twin wheel casters for easy mobility



Bell glides (optional -BG)



Banded

Heavy Duty Edge Options

We Can outfit any desk, table or top with any number of heavy duty edge banding options. 3mm PVC, T-mold PVC or Lotz Armor Edge™ are all available to provide a custom edge to your work surface. Various options of square or radius corners and beveled or radius edges are also available. Contact our Customer Service Team for the perfect edge.

1. Lotz Armor Edge™ Radius
2. Lotz Armor Edge™ Beveled
3. 3mm PVC Square Corner
4. 3mm PVC Radius Corner
5. PVC T-Mold Radius Corner

top

Post-Formed

Laminate Wrapped

At WB Manufacturing, **We Can**, and we are, laminate tops. Choose from a variety of laminate edge options, available on most tables, desks and tops. Comfort Edge, Ergo Edge, 180° Bullnose Edge, 90° Modern Edge and Square Edge are just a few of your options. Contact our Customer Service Team for details.

1. Comfort Edge
2. Ergo Edge
3. 180° Bullnose Edge
4. 90° Modern Edge
5. Square Edge



options

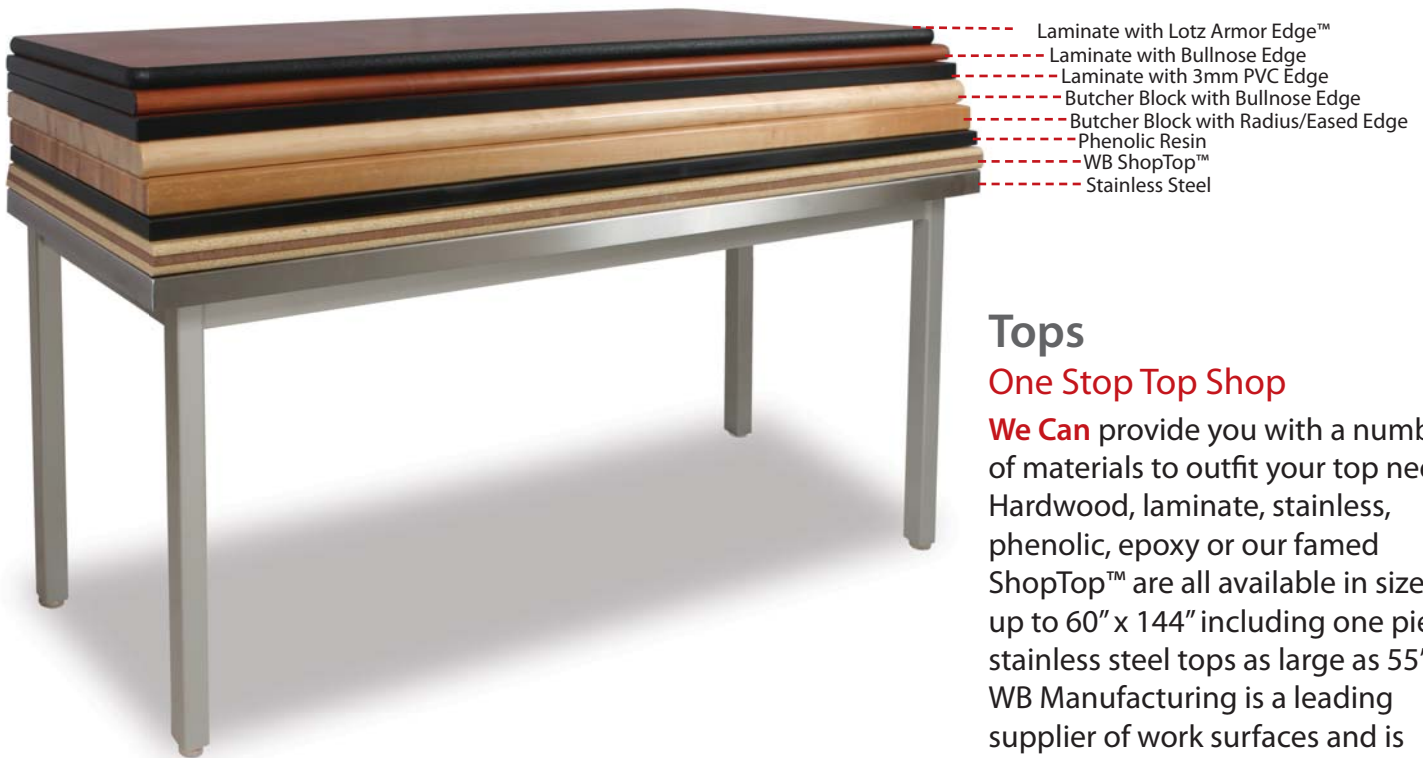

Tops

One Stop Top Shop

We Can provide you with a number of materials to outfit your top needs. Hardwood, laminate, stainless, phenolic, epoxy or our famed ShopTop™ are all available in sizes up to 60" x 144" including one piece stainless steel tops as large as 55"D. WB Manufacturing is a leading supplier of work surfaces and is ready to design, build and deliver your next custom solution.

We Can.
DESIGN. BUILD. DELIVER.

power

Power

Power For Your Application

We Can provide multiple power options to your students or employees with power modules. Power modules are available on most desks, tables and tops; simply look for the **PWR** logo throughout the catalog to add power to your project. Contact our Customer Service Team for details.



Axil® Z



Ellora®



Glenbeigh® Contemporary



Hemisphere™



Mho®



Mho2®



Mini-Port®



Node®



RPC® (Flush Mount)



Salt

Power Modules*

Model	Description
Axil® Z	2 Power Outlets, 1 USB 2 Port Charger, 1 Open Data Ports, 72" cord
Ellora®	2 Power Outlets, 1 USB 2 Port Charger, 1 Open Data Ports, 72" cord
Glenbeigh® Contemporary	1 Power Outlet, 1 USB 2 Port Charger, 72" cord
Hemisphere™	2 Power Outlets, 1 USB 2 Port Charger, 72" cord
Mho®	2 Power Outlets, 1 USB 2 Port Charger, 1 HDMI, 72" cord
Mho2®	4 Power Outlets, 3 Open Data Ports, 72" cord
Mini-Port®	2 Power Outlets, 2 Open Data Ports, 72" cord
Node®	1 Power Outlet, 1 USB 2 Port Charger, 72" cord
RPC®	4 Power Outlets, 72" cord (Flush Mount Retractable)
Salt	1 USB 2 Port Charger, 72" cord

*Must be ordered at time of purchase of desk/tables/tops for which they are intended.



options

ELO® Bridge Table

Glenbeigh® Contemporary PWR



ELO® Adapt Desk

Salt PWR



We Can.
DESIGN. BUILD. DELIVER.



LOB7082-ADJ



LOB0082-ADJ

LOBO Table

The Essential Table

Our all-purpose, heavy duty LOBO table is durable and versatile and can often be found in use in general classrooms, industrial arts classrooms, conference centers and manufacturing environments. This workhorse of a table is certain to fit all your needs. Choose from six different top options in 28 standard sizes and four leg options with either casters or glides to build your ideal table. Need a size or color you don't see offered? Call us for custom options.

LOBO



LOB8082-FX-SS



Need a size or top you don't see? Contact our Customer Service Team for custom options.



LOB9082-ADJ

LOBO Table Overview

- Frame:** 16-gauge 1" x 2" heavy duty fully welded steel frame apron and bolt-on legs
- Fixed Legs:** 14-gauge 1.5" square steel tube, 28.5" height
- Adj Legs:** 14-gauge 1.5" square steel tube(22.5"-36.5"), 2" round steel tube(22.25"-36.25) & 2" Big Paw square tube(22.25-36.25) height in 1" increments
- Laminate Top:** 1.25" high pressure laminate (HPL) with phenolic backer, radius corners, 3mm PVC edge banding or radius Lotz Armor Edge™
- Finish:** Standard or custom laminate
- Lab Top:** 1" phenolic resin or black epoxy with 0.125" radius edge
- Hardwood Top:** 1.75" face-glued hardwood strips with 0.125" radius edge and clear catalyzed lacquer finish 2 coats top, 1 coat bottom
- Maple Top:** 1.75" face-glued maple strips with 0.125" radius edge and catalyzed lacquer finish 2 coats top, 1 coat bottom
- Stainless Top:** 16-gauge stainless steel with particle board core, 1.625" thick, wrapped and welded corners, 304 finish
- Optional:** Chemical resistant laminate available-call Estimating Dept., dual wheel locking casters*(caster raises heights by approx. 2"), 3" heavy duty casters*(caster raises heights by 4"), steel glides, 2.5" Grand Hank Glide, bolt-on Corner Gussets Kit**
 - *Casters are NOT to be used as leveling devices and requires field assembly.
 - ** "Corner Gusset Kit: Recommended for all tables (LOBO or TORO) with caster option, table size exceeds 30" x 72" or intended table use heights greater than 31" for increased stability."



0.3125" bolt secures leg to 10-gauge reception plate



Welded plate and #10 screws secure leg to top



Bolt-on leg gussets provide increased stability (optional)



0.375" threaded nylon glides (standard)



Dual wheel casters-raises heights by approx. 2" (optional)



Adjustable legs adjust in 1" increments with tamper resistant screws

HPL Standard Laminate Color Options

(-KA)	(-94)	(-32)	(-209)	(-AA)	(-66)	(-09)	(-25)	(-05)
(-EM)	(-04)	(-03)	(-60)	(-HL)	(-A41)	(-C09)	(-A91)	(-D08)

*Stocked in limited sizes & quantities. Contact Customer Service for lead time.

Complimentary edgeband option for these laminates, matching edgebanding unavailable.

Frame Color Options**

Textured Black (standard)	Smooth Silver		
---------------------------	---------------	--	--

**See page 54 for a list of all our LOBO legs and what colors they are available in.



LOBO Tables



Rectangle

Laminate with Lotz Armor Edge™	Laminate with 3MM Edge	Lab Top	Hardwood	Maple	Stainless Steel	Top DxL
LOB7067	LOB6067	LOB8067	LOB9067	LOB9067M		24" x 36"
LOB7068	LOB6068	LOB8068	LOB9068	LOB9068M		24" x 42"
LOB7069	LOB6069	LOB8069	LOB9069	LOB9069M	LOB0069	24" x 48"*
LOB7070	LOB6070	LOB8070	LOB9070	LOB9070M	LOB0070	24" x 54"*
LOB7071	LOB6071	LOB8071	LOB9071	LOB9071M	LOB0071	24" x 60"*
LOB7072	LOB6072	LOB8072	LOB9072	LOB9072M	LOB0072	24" x 72"
LOB7073	LOB6073	LOB8073	LOB9073	LOB9073M		24" x 84"
LOB7074	LOB6074	LOB8074	LOB9074	LOB9074M	LOB0074	24" x 96"
LOB7078	LOB6078	LOB8078	LOB9078	LOB9078M		30" x 36"
LOB7079	LOB6079	LOB8079	LOB9079	LOB9079M		30" x 42"
LOB7080	LOB6080	LOB8080	LOB9080	LOB9080M		30" x 48"
LOB7082	LOB6082	LOB8082	LOB9082	LOB9082M		30" x 60"*
LOB7083	LOB6083	LOB8083	LOB9083	LOB9083M		30" x 72"*
LOB7084	LOB6084	LOB8084	LOB9084	LOB9084M		30" x 84"
LOB7085	LOB6085	LOB8085	LOB9085	LOB9085M	LOB0085	30" x 96"
LOB7088	LOB6088	LOB8088	LOB9088	LOB9086M		36" x 36"
LOB7089	LOB6089	LOB8089	LOB9089	LOB9089M		36" x 42"
LOB7090	LOB6090	LOB8090	LOB9090	LOB9090M		36" x 48"
LOB7092	LOB6092	LOB8092	LOB9092	LOB9092M	LOB0092	36" x 60"
LOB7093	LOB6093	LOB8093	LOB9093	LOB9093M	LOB0093	36" x 72"*
LOB7094	LOB6094	LOB8094	LOB9094	LOB9094M		36" x 84"
LOB7095	LOB6095	LOB8095	LOB9095	LOB9095M	LOB0095	36" x 96"
LOB7098	LOB6098	LOB8098	LOB9098	LOB9098M		42" x 42"
LOB7099	LOB6099	LOB8099	LOB9099**	LOB9099M**	LOB0099	42" x 60"*
LOB7100	LOB6100	LOB8100	LOB9100**	LOB9100M**	LOB0100	42" x 72"
LOB7107	LOB6107	LOB8107	LOB9107**	LOB9107M**		48" x 48"
LOB7108	LOB6108	LOB8108	LOB9108**	LOB9108M**	LOB0108	48" x 60"
LOB7109	LOB6109	LOB8109	LOB9109**	LOB9109M**	LOB0109	48" x 72"
LOB7111	LOB6111	LOB8111	LOB9111**	LOB9111M**	LOB0111	48" x 96"



LOBO tables are available with 4 leg options.

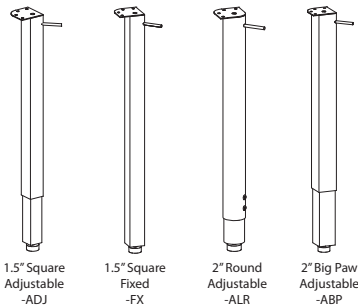

-ADJ and -ALR are available in Black and Smooth Silver
-FX and -ABP are only available in Black



*Frame size is stocked.
**Top is in 2 pieces, .5\" undersized, field assembled with joint connector bolt.

Drilling for frames on rectangle tops with AE™ has an extra charge.
Any premium or scratch resistant laminate is an upcharge.

Contact Customer Service for info on epoxy top tables.

Laminate top Lobo tables also available in these shapes, contact our Customer Service Team.





Colstrip High School, MT

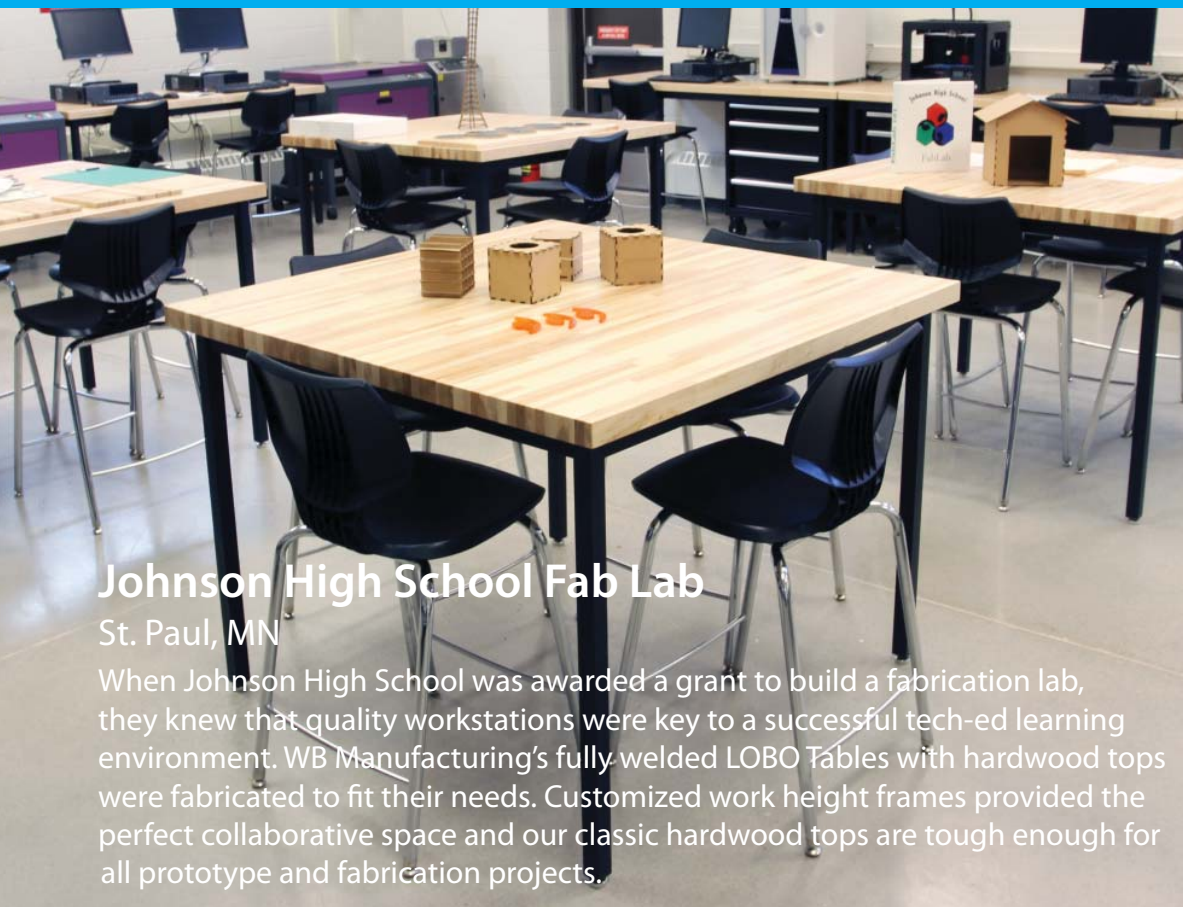

Johnson High School Fab Lab

St. Paul, MN

When Johnson High School was awarded a grant to build a fabrication lab, they knew that quality workstations were key to a successful tech-ed learning environment. WB Manufacturing's fully welded LOBO Tables with hardwood tops were fabricated to fit their needs. Customized work height frames provided the perfect collaborative space and our classic hardwood tops are tough enough for all prototype and fabrication projects.





TORO Table

Heavy Duty Table

No bull, these tables feature 14-gauge steel legs welded to a 16-gauge fully welded steel frame and apron. Built tough to withstand abuse in specialized industrial settings and industrial environments, the TORO table delivers style and unbeatable performance.

TORO

TORO table leg options

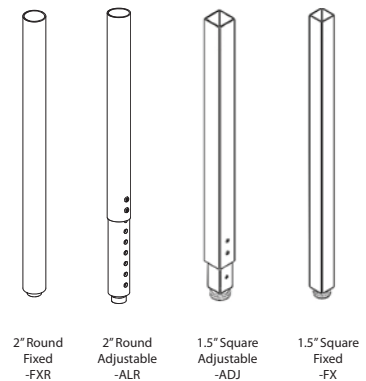

TORO Tables

Laminate with Lotz Armor Edge™

Laminate with 3MM Edge

Lab Top

Hardwood

Maple

Stainless

Top DxDL

TOR7069	TOR6069	TOR8069	TOR9069	TOR9069M	TOR0069	24" x 48"
TOR7071	TOR6071	TOR8071	TOR9071	TOR9071M	TOR0071	24" x 60"
TOR7072	TOR6072	TOR8072	TOR9072	TOR9072M	TOR0072	24" x 72"
TOR7082	TOR6082	TOR8082	TOR9082	TOR9082M	TOR0082	30" x 60"
TOR7083	TOR6083	TOR8083	TOR9083	TOR9083M	TOR0083	30" x 72"
TOR7085	TOR6085	TOR8085	TOR9085	TOR9085M	TOR0085	30" x 96"
TOR7092	TOR6092	TOR8092	TOR9092	TOR9092M	TOR0092	36" x 60"
TOR7093	TOR6093	TOR8093	TOR9093	TOR9093M	TOR0093	36" x 72"
TOR7095	TOR6095	TOR8095	TOR9095	TOR9095M	TOR0095	36" x 96"
TOR7099	TOR6099	TOR8099	TOR9099*	TOR9099M*	TOR0099	42" x 60"
TOR7100	TOR6100	TOR8100	TOR9100*	TOR9100M*	TOR0100	42" x 72"
TOR7109	TOR6109	TOR8109	TOR9109*	TOR9109M*	TOR0109	48" x 72"
TOR7111	TOR6111	TOR8111	TOR9111*	TOR9111M*	TOR0111	48" x 96"

Lotz Armor Edge™

Laminate 3MM

Lab Top

Hardwood

Maple

Stainless Steel

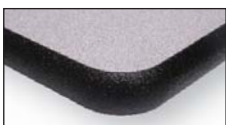

*Top is in 2 pieces, .5" oversized, field assembled with joint connector bolt.

TORO Table Overview

- Frame: Fully welded 16-gauge 1" x 2" heavy duty steel apron with fully welded legs
- Fixed Legs: 14-gauge 1.5" square steel tube and 2" round steel tube, 28.5" height
- Adj Legs: 14-gauge 1.5" square steel tube(22.5" to 36.5") and 2" round steel tube(22.25"-36.25") height in 1" increments
- Laminate Top: 1.25" high pressure laminate (HPL) with phenolic backer, radius corners, 3mm PVC edge band or radius Lotz Armor Edge™
- Finish: Standard or custom laminate
- Lab Top: 1" phenolic resin with 0.125" radius edge
- Hardwood Top: 1.75" face-glued hardwood strips with 0.125" radius edge and catalyzed lacquer finish 2 coats top, 1 coat bottom
- Maple Top: 1.75" face-glued maple strips with 0.125" radius edge and clear catalyzed lacquer finish 2 coats top, 1 coat bottom
- Stainless Top: 16-gauge stainless steel with particle board core, 1.625" thick, wrapped and welded corners, 304 finish
- Optional: Chemical resistant laminate available-call Estimating Dept., 3" heavy duty casters*(caster raises heights by 4"), steel glides, 2.5" Grand Hank Glide, welded gussets, custom heights and table top sizes, welded-on Corner Gussets**
 *Casters are NOT to be used as leveling devices and requires field assembly.
 **"Corner Gusset Kit: Recommended for all tables (LOBO or TORO) with caster option, table size exceeds 30" x 72" or intended table use heights greater than 31" for increased stability."



Fully welded frame and legs for superior strength



Welded leg gussets provide increased stability (optional)



0.375" threaded nylon glides (standard)



Adjustable legs adjust in 1" increments with tamper resistant screws



3" heavy duty casters-raises heights by 4" (optional)



2.5" Grand Hank Glide (optional)

HPL Standard Laminate Color Options



*Stocked in limited sizes & quantities. Contact Customer Service for lead time.

Complimentary edgeband option for these laminates, matching edgebanding unavailable.

Frame Color Options

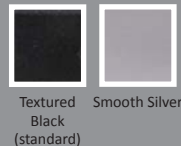

Huntley High School, IL



TOR7500-ADJ

TORO Connect Desk

TORO Tough

TORO Connect Desks feature a fully welded frame and high pressure laminate work surface with beveled Lotz Armor Edge™ that seals and protects the edges from damage (3mm PVC optional). Comfort curve on the student side offers each student a spacious work area and a sense of place. Suitable for individual study or connect 2, 4, or 8 desks for large or small group work. Available in fixed or adjustable legs with non-marring adjustable glides or optional casters.



TOR7215-ADJ

TORO

TORO Connect Desks

TORO Connect 8



AE Top	3MM Top	Description	Top DxL	Desk H
TOR7215-FX	TOR6215-FX	TORO Connect 8 with fixed legs	22" x 32.5"	28.25"
TOR7215-ADJ	TOR6215-ADJ	TORO Connect 8 with adj. legs	22" x 32.5"	21.5"-33.5"



TOR7215-FX

TORO Ocho



AE Top	3MM Top	Description	Top DxL	Desk H
TOR7500-ADJ	TOR6500-ADJ	TORO Ocho with adj. legs	20" x 35"	21.5"-33.5"



TOR7500-ADJ



Power and media modules available. See page 50.

TORO Connect Desk Overview

- Frame: Fully welded 14-gauge 1.25" square steel tube
 - Fixed Legs: Fully welded 14-gauge 1.25" square steel tube, 27" frame height
 - Adj Legs: Fully welded 14-gauge 1.25" square steel tube with adjustable insert, 20.25" to 32.25" frame height in 1" increments
 - Laminate Top: 1.25" high pressure laminate (HPL) with phenolic backer
 - Edge Banding: Beveled Lotz Armor Edge™ or 3mm PVC
 - Finish: Standard or custom laminate
 - Power: Modules for power and media (optional, with most desks)
 - Optional: Dual wheel casters*(caster raises height by approx. 2"), 2.5" Grand Hank Glide, tote tray storage, book box, backpack hook (optional items available on most desk models)
- *Casters are NOT to be used as leveling devices and requires field assembly.



Beveled edge with Lotz Armor Edge™

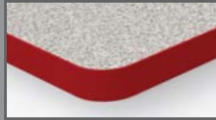

3mm PVC



Glide & Tilt tote tray storage (optional) (can be interchanged with Tote Storage Unit)



Steel book box (optional)



Adjustable legs adjust in 1" increments with tamper resistant screws



Fully welded frame attached via screws

HPL Standard Laminate Color Options

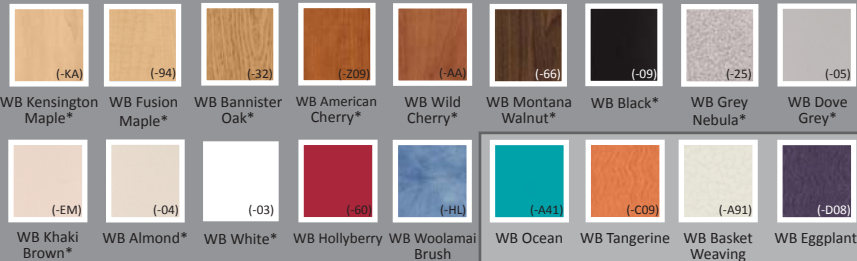

*Stocked in limited sizes & quantities. Contact Customer Service for lead time.

Frame Color Options



Dual wheel casters-raises heights by approx. 2" (optional)



2.5" Grand Hank Glide (optional)



Complete Laminate Collections Available



Backpack hook (optional)

Complimentary edgeband option for these laminates, matching edgebanding unavailable.



Hudson Middle School, WI



ELO® Café Table

Gather Together
 Give your breakroom or student commons area a face lift with ELO® Café tables and seating. These fully welded steel frame tables feature contemporary styling and are virtually maintenance free with no screws to retighten. Designed for highly trafficked areas, ELO® Café tables feature high pressure laminate tops with Lotz Armor Edge™ that seals and protects edges from moisture and damage. You may also choose a 3mm PVC edge. Stools are fully welded and have matching finishes and comfort height welded foot ring. Non-marring glides on table and stool.



ELO® Café

ELO® Café Tables

<i>36" Round Top Table</i>	<i>42" Round Top Table</i>	<i>36" Square Top Table</i>	<i>42" Square Top Table</i>	<i>Table Height</i>
ELC7190-30	ELC7191-30	ELC7088-30	ELC7098-30	30"
ELC7190-42	ELC7191-42	ELC7088-42	ELC7098-42	42"

ELO® Café Stool Seating

<i>18" Seat Height</i>	<i>30" Seat Height</i>
STL-7E18-NSS	STL-7E30-NSS



ELO® Café Table and Stool Overview

Frame: Fully welded 16-gauge arched steel tube legs with 12-gauge mounting plates, textured black finish, nylon glides

Top: 1.25" high pressure laminate (HPL), phenolic backer

Stool Frame: Fully welded 16-gauge arched steel tube legs and foot ring, textured black finish, nylon glides

Stool Seat: 0.75" HPL

Finish: Standard or custom laminate

Edge Banding: 3mm PVC or beveled Lotz Armor Edge™



Fully welded steel frames

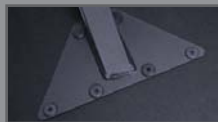

Table top attaches with threaded inserts and bolts



Threaded case hardened self-leveling nylon glides



Beveled Lotz Armor Edge™



2.5" Nylon Glide (optional)

HPL Standard Laminate Color Options

WB Kensington Maple*	WB Fusion Maple*	WB Bannister Oak*	WB American Cherry*	WB Wild Cherry*	WB Montana Walnut*	WB Black*	WB Grey Nebula*	WB Dove Grey*
WB Khaki Brown*	WB Almond*	WB White*	WB Hollyberry	WB Woolamai Brush	WB Ocean	WB Tangerine	WB Basket Weaving	WB Eggplant

*Stocked in limited sizes & quantities. Contact Customer Service for lead time.

Complimentary edgeband option for these laminates, matching edgebanding unavailable.

Frame Color Option

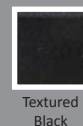

Textured Black



Complete Laminate Collections Available





ELO® Tables & Desks Signature Series

These versatile desks & tables can be easily adapted for large groups, small teams or individual learning activities.

Our vast selection of desk & table top shapes and sizes allows you to configure desk & table shapes into multiple variations to promote collaborative learning environments. The ELO® Desk & Table features contemporary curved legs positioned at the widest point providing maximum stability, comfort and knee clearance for students of all ages. Non-marring adjustable glides protect floors, or optional casters are available for ease of movement.



ELO

ELO® Table and Desk Overview

Power and media modules available. See page 50.



ELO Legs Overview:	14-gauge tube with 12-gauge mounting plate and 1" 14-gauge insert, nylon glides
1.25" Square Adj. Legs:	ADJ Legs: 24.75" to 29.75" leg hgt. in 1" incr. JR Legs: 20" to 25" leg hgt. in 1" incr. StandUp Legs*: 32.25" to 42.25" leg hgt. in 1" incr.
2" Curved Rd Adj. Legs:	ADJ Legs: 25" to 30" leg height in 1" increments JR Legs: 21" to 26" leg height in 1" increments
2" Straight Rd Adj. Legs:	ADJ Legs: 29.25" to 42.25" leg height in 1" increments JR Legs: 20" to 33" leg height in 1" increments
Laminate Top**:	1.25" high pressure laminate (HPL) with phenolic backer
Edge Banding:	Beveled Lotz Armor Edge™ (standard) or 3mm PVC
Finish:	Standard or custom laminate
Power:	Modules for power and media (optional, with most desks)
Optional:	Chemical resistant & markerboard laminates available on ELO® tables and markerboard laminate available on ELO® desks-call Estimating Dept., Dual wheel locking casters*** (caster raises heights by approx. 2"), 2.5 Grand Hank Glide, tote tray storage, book box, backpack hook (optional items available on most desk models), all ELO® tables and desks can be ordered ADA compliant ***Casters are NOT to be used as leveling devices and requires field assembly.

*1.25" Square StandUp Legs only available in the desk options

**All ELO® table and desk tops can be enlarged, contact Customer Service for further info.



Beveled edge with Lotz Armor Edge™

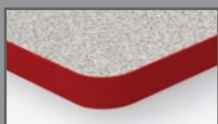

3mm PVC



Glide & Tilt tote tray storage (optional) (can be interchanged with Tote Storage Unit)



Steel book box (optional)



Adjustable legs adjust in 1" increments with tamper resistant screws

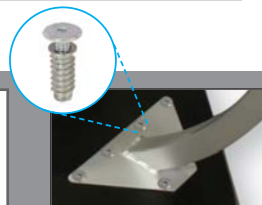

Legs positioned at widest point of desk for stability and attached via threaded metal inserts and screws

HPL Standard Laminate Color Options

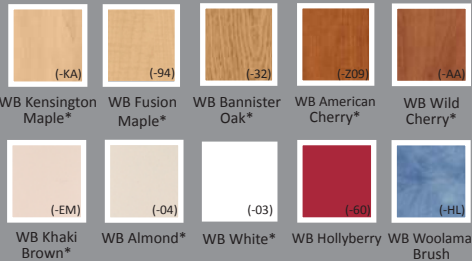

*Stocked in limited sizes & quantities. Contact Customer Service for lead time.

Frame Color Options

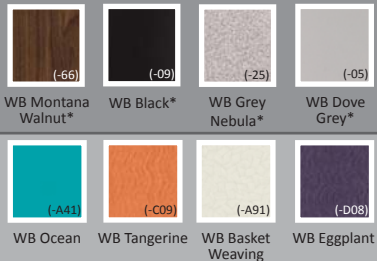

Complimentary edgeband option for these laminates, matching edgebanding unavailable.

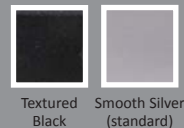

Complete Laminate Collections Available



2.5" Grand Hank Glide (optional)



Backpack hook (optional)



Dual wheel casters-raises heights by approx. 2" (optional)

Leg Options for ELO® Tables

ELO® Leg Options (ELO6191-)



Adj. legs
-ADJ



Jr. legs
-EJA

2" Curved Round ELO® Leg Options (ELR6191-)



Adj. legs
-ADJ



Jr. legs
-EJA

2" Straight Round ELO® Leg Options (ELS6191-)



Adj. legs
-ADJ*

*With caster option, min. height is 31.25", you will need to select -EJA legs(Jr.) for sitting height.



Jr. legs
-EJA

Leg Options for ELO® Desks

ELO® Leg Options (ELO6171-)



Adj. legs
-ADJ



Jr. legs
-EJA



StandUp legs
-ADJSU

2" Curved Round ELO® Leg Options (ELR6171-)



Adj. legs
-ADJ



Jr. legs
-EJA

2" Straight Round ELO® Leg Options (ELS6171-)



Adj. legs (sit position)
-ADJ*



Adj. legs (stand position)
-ADJ*

*With caster option, min. height is 31.25", you will need to select -EJA legs(Jr.) for sitting height.



Jr. legs (sit position)
-EJA



Jr. legs (stand position)
-EJA

ELO® table

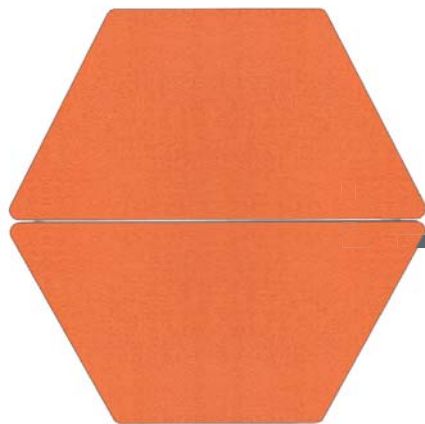
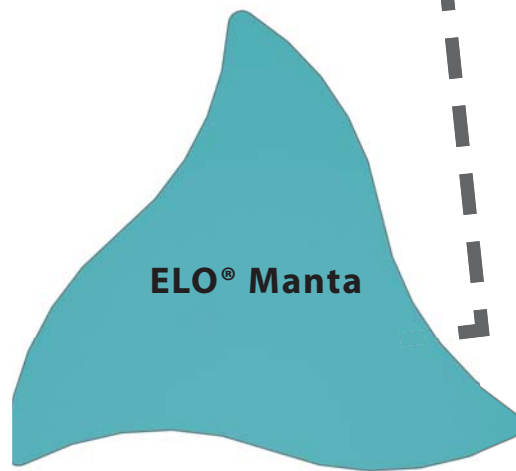
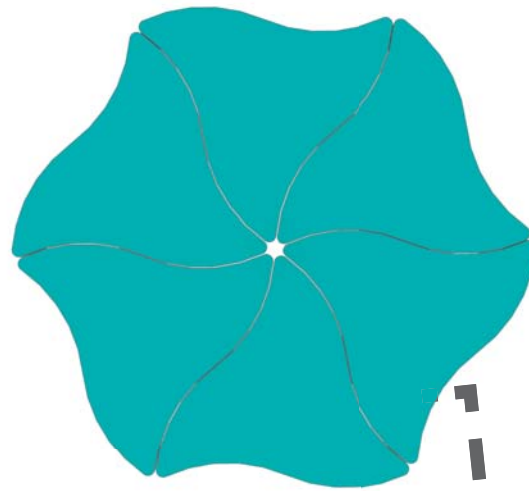
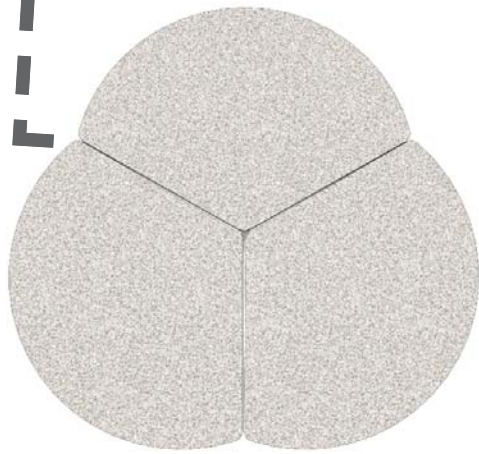

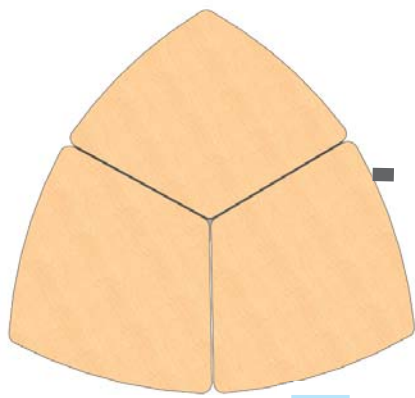

shapes

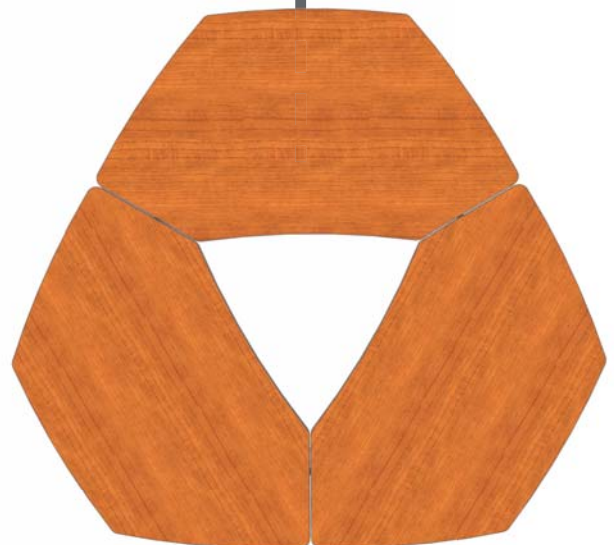

Table Tops

What's in a Shape?

Not only does the shape of a table top allow for simple connecting of units, but each different shape allows for better arrangement of materials on the work surface. Collaboration and group work is easier, more comfortable and contemporary with ELO® Collaborative Tables. The students will enjoy the fun shapes and quick transformation of the classroom and the teachers will love the ease of grouping work areas. Ask our Customer Service Team today how ELO® Collaborative tables can help shape up your classroom.

ELO® Table

ELO® Tri-Tables



<i>AE Top</i>	<i>3MM Top</i>	<i>Description</i>	<i>Top DxL</i>	<i>Table H</i>
ELO7801-ADJ	ELO6801-ADJ	6 adj. legs	60" x 68.82"	26"-31"
ELO7801-EJA	ELO6801-EJA	6 jr. adj. legs	60" x 68.82"	21.25"-26.25"
ELR7801-ADJ	ELR6801-ADJ	6 curved round adj. legs	60" x 68.82"	26.25"-31.25"
ELR7801-EJA	ELR6801-EJA	6 jr. curved round adj. legs	60" x 68.82"	22.25"-27.25"
ELS7801-ADJ	ELS6801-ADJ	6 straight round adj. legs	60" x 68.82"	30.5"-43.5"
ELS7801-EJA	ELS6801-EJA	6 jr. straight round adj. legs	60" x 68.82"	21.25"-34.25"



ELO6801-ADJ

ELO® Bridge Tables



<i>AE Top</i>	<i>3MM Top</i>	<i>Description</i>	<i>Top DxL</i>	<i>Table H</i>
ELO7802-ADJ	ELO6802-ADJ	4 adj. legs	33.3" x 61"	26"-31"
ELO7802-EJA	ELO6802-EJA	4 jr. adj. legs	33.3" x 61"	21.25"-26.25"
ELR7802-ADJ	ELR6802-ADJ	4 curved round adj. legs	33.3" x 61"	26.25"-31.25"
ELR7802-EJA	ELR6802-EJA	4 jr. curved round adj. legs	33.3" x 61"	22.25"-27.25"
ELS7802-ADJ	ELS6802-ADJ	4 straight round adj. legs	33.3" x 61"	30.5"-43.5"
ELS7802-EJA	ELS6802-EJA	4 jr. straight round adj. legs	33.3" x 61"	21.25"-34.25"



ELO6802-ADJ

ELO® Circlet Tables



<i>AE Top</i>	<i>3MM Top</i>	<i>Description</i>	<i>Top DxL</i>	<i>Table H</i>
ELO7803-ADJ	ELO6803-ADJ	4 adj. legs	35.5" x 50"	26"-31"
ELO7803-EJA	ELO6803-EJA	4 jr. adj. legs	35.5" x 50"	21.25"-26.25"
ELR7803-ADJ	ELR6803-ADJ	4 curved round adj. legs	35.5" x 50"	26.25"-31.25"
ELR7803-EJA	ELR6803-EJA	4 jr. curved round adj. legs	35.5" x 50"	22.25"-27.25"
ELS7803-ADJ	ELS6803-ADJ	4 straight round adj. legs	35.5" x 50"	30.5"-43.5"
ELS7803-EJA	ELS6803-EJA	4 jr. straight round adj. legs	35.5" x 50"	21.25"-34.25"



ELO6803-ADJ

ELO® Nimbus Tables



<i>AE Top</i>	<i>3MM Top</i>	<i>Description</i>	<i>Top DxL</i>	<i>Table H</i>
ELO7808-ADJ	ELO6808-ADJ	3 adj. legs	39.25" x 55.5"	26"-31"
ELO7808-EJA	ELO6808-EJA	3 jr. adj. legs	39.25" x 55.5"	21.25"-26.25"
ELR7808-ADJ	ELR6808-ADJ	3 curved round adj. legs	39.25" x 55.5"	26.25"-31.25"
ELR7808-EJA	ELR6808-EJA	3 jr. curved round adj. legs	39.25" x 55.5"	22.25"-27.25"
ELS7808-ADJ	ELS6808-ADJ	3 straight round adj. legs	39.25" x 55.5"	30.5"-43.5"
ELS7808-EJA	ELS6808-EJA	3 jr. straight round adj. legs	39.25" x 55.5"	21.25"-34.25"



ELO6808-ADJ

ELO® Reef Tables



<i>AE Top</i>	<i>3MM Top</i>	<i>Description</i>	<i>Top DxL</i>	<i>Table H</i>
ELO7804-ADJ	ELO6804-ADJ	4 adj. legs	30" x 54"	26"-31"
ELO7804-EJA	ELO6804-EJA	4 jr. adj. legs	30" x 54"	21.25"-26.25"
ELR7804-ADJ	ELR6804-ADJ	4 curved round adj. legs	30" x 54"	26.25"-31.25"
ELR7804-EJA	ELR6804-EJA	4 jr. curved round adj. legs	30" x 54"	22.25"-27.25"
ELS7804-ADJ	ELS6804-ADJ	4 straight round adj. legs	30" x 54"	30.5"-43.5"
ELS7804-EJA	ELS6804-EJA	4 jr. straight round adj. legs	30" x 54"	21.25"-34.25"



ELO® Tide Tables



<i>AE Top</i>	<i>3MM Top</i>	<i>Description</i>	<i>Top DxL</i>	<i>Table H</i>
ELO7805-ADJ	ELO6805-ADJ	4 adj. legs	30" x 54"	26"-31"
ELO7805-EJA	ELO6805-EJA	4 jr. adj. legs	30" x 54"	21.25"-26.25"
ELR7805-ADJ	ELR6805-ADJ	4 curved round adj. legs	30" x 54"	26.25"-31.25"
ELR7805-EJA	ELR6805-EJA	4 jr. curved round adj. legs	30" x 54"	22.25"-27.25"
ELS7805-ADJ	ELS6805-ADJ	4 straight round adj. legs	30" x 54"	30.5"-43.5"
ELS7805-EJA	ELS6805-EJA	4 jr. straight round adj. legs	30" x 54"	21.25"-34.25"



ELO® Manta Tables



<i>AE Top</i>	<i>3MM Top</i>	<i>Description</i>	<i>Top DxL</i>	<i>Table H</i>
ELO7806-ADJ	ELO6806-ADJ	3 adj. legs	48" x 52"	26"-31"
ELO7806-EJA	ELO6806-EJA	3 jr. adj. legs	48" x 52"	21.25"-26.25"
ELR7806-ADJ	ELR6806-ADJ	3 curved round adj. legs	48" x 52"	26.25"-31.25"
ELR7806-EJA	ELR6806-EJA	3 jr. curved round adj. legs	48" x 52"	22.25"-27.25"
ELS7806-ADJ	ELS6806-ADJ	3 straight round adj. legs	48" x 52"	30.5"-43.5"
ELS7806-EJA	ELS6806-EJA	3 jr. straight round adj. legs	48" x 52"	21.25"-34.25"



ELO® Link Tables



<i>AE Top</i>	<i>3MM Top</i>	<i>Description</i>	<i>Top DxL</i>	<i>Table H</i>
ELO7812-ADJ	ELO6812-ADJ	4 adj. legs	44.88" x 65"	26"-31"
ELO7812-EJA	ELO6812-EJA	4 jr. adj. legs	44.88" x 65"	21.25"-26.25"
ELR7812-ADJ	ELR6812-ADJ	4 curved round adj. legs	44.88" x 65"	26.25"-31.25"
ELR7812-EJA	ELR6812-EJA	4 jr. curved round adj. legs	44.88" x 65"	22.25"-27.25"
ELS7812-ADJ	ELS6812-ADJ	4 straight round adj. legs	44.88" x 65"	30.5"-43.5"
ELS7812-EJA	ELS6812-EJA	4 jr. straight round adj. legs	44.88" x 65"	21.25"-34.25"







ELO® Table

ELO® Broadhead Tables



<i>AE Top</i>	<i>3MM Top</i>	<i>Description</i>	<i>Top DxL</i>	<i>Table H</i>
ELO7315-ADJ	ELO6315-ADJ	4 adj. legs	32" x 40"	26"-31"
ELO7315-EJA	ELO6315-EJA	4 jr. adj. legs	32" x 40"	21.25"-26.25"
ELR7315-ADJ	ELR6315-ADJ	4 curved round adj. legs	32" x 40"	26.25"-31.25"
ELR7315-EJA	ELR6315-EJA	4 jr. curved round adj. legs	32" x 40"	22.25"-27.25"
ELS7315-ADJ	ELS6315-ADJ	4 straight round adj. legs	32" x 40"	30.5"-43.5"
ELS7315-EJA	ELS6315-EJA	4 jr. straight round adj. legs	32" x 40"	21.25"-34.25"



ELO6315-ADJ

ELO® Double Diamond Tables



<i>AE Top</i>	<i>3MM Top</i>	<i>Description</i>	<i>Top DxL</i>	<i>Table H</i>
ELO7319-ADJ	ELO6319-ADJ	4 adj. legs	36" x 60"	26"-31"
ELO7319-EJA	ELO6319-EJA	4 jr. adj. legs	36" x 60"	21.25"-26.25"
ELR7319-ADJ	ELR6319-ADJ	4 curved round adj. legs	36" x 60"	26.25"-31.25"
ELR7319-EJA	ELR6319-EJA	4 jr. curved round adj. legs	36" x 60"	22.25"-27.25"
ELS7319-ADJ	ELS6319-ADJ	4 straight round adj. legs	36" x 60"	30.5"-43.5"
ELS7319-EJA	ELS6319-EJA	4 jr. straight round adj. legs	36" x 60"	21.25"-34.25"



ELO6319-ADJ

ELO® Spooner Tables



<i>AE Top</i>	<i>3MM Top</i>	<i>Description</i>	<i>Top DxL</i>	<i>Table H</i>
ELO7322-ADJ	ELO6322-ADJ	4 adj. legs	40.75" x 71.75"	26"-31"
ELO7322-EJA	ELO6322-EJA	4 jr. adj. legs	40.75" x 71.75"	21.25"-26.25"
ELR7322-ADJ	ELR6322-ADJ	4 curved round adj. legs	40.75" x 71.75"	26.25"-31.25"
ELR7322-EJA	ELR6322-EJA	4 jr. curved round adj. legs	40.75" x 71.75"	22.25"-27.25"
ELS7322-ADJ	ELS6322-ADJ	4 straight round adj. legs	40.75" x 71.75"	30.5"-43.5"
ELS7322-EJA	ELS6322-EJA	4 jr. straight round adj. legs	40.75" x 71.75"	21.25"-34.25"



ELO7322-ADJ

ELO® Hubbard Tables



<i>AE Top</i>	<i>3MM Top</i>	<i>Description</i>	<i>Top DxL</i>	<i>Table H</i>
ELO7817-ADJ	ELO6817-ADJ	4 adj. legs	34.46" x 47.59"	26"-31"
ELO7817-EJA	ELO6817-EJA	4 jr. adj. legs	34.46" x 47.59"	21.25"-26.25"
ELR7817-ADJ	ELR6817-ADJ	4 curved round adj. legs	34.46" x 47.59"	26.25"-31.25"
ELR7817-EJA	ELR6817-EJA	4 jr. curved round adj. legs	34.46" x 47.59"	22.25"-27.25"
ELS7817-ADJ	ELS6817-ADJ	4 straight round adj. legs	34.46" x 47.59"	30.5"-43.5"
ELS7817-EJA	ELS6817-EJA	4 jr. straight round adj. legs	34.46" x 47.59"	21.25"-34.25"



ELO6817-ADJ

Add Color to your classroom with the Manta, Reef and Tide collection!



ELO® Manta Tables



ELO® Reef & Tide Tables



ELO® Reef, Tide & Manta Tables



ELO® Reef Tables

ELO® Table

ELO® Round Tables

<i>AE Top</i>	<i>3MM Top</i>	<i>Description</i>	<i>Top Dia.</i>	<i>Table H</i>
ELO7190-ADJ	ELO6190-ADJ	4 adj. legs	36"	26"-31"
ELO7190-EJA	ELO6190-EJA	4 jr. adj. legs	36"	21.25"-26.25"
ELR7190-ADJ	ELR6190-ADJ	4 curved round adj. legs	36"	26.25"-31.25"
ELR7190-EJA	ELR6190-EJA	4 jr. curved round adj. legs	36"	22.25"-27.25"
ELS7190-ADJ	ELS6190-ADJ	4 straight round adj. legs	36"	30.5"-43.5"
ELS7190-EJA	ELS6190-EJA	4 jr. straight round adj. legs	36"	21.25"-34.25"
ELO7191-ADJ	ELO6191-ADJ	4 adj. legs	42"	26"-31"
ELO7191-EJA	ELO6191-EJA	4 jr. adj. legs	42"	21.25"-26.25"
ELR7191-ADJ	ELR6191-ADJ	4 curved round adj. legs	42"	26.25"-31.25"
ELR7191-EJA	ELR6191-EJA	4 jr. curved round adj. legs	42"	22.25"-27.25"
ELS7191-ADJ	ELS6191-ADJ	4 straight round adj. legs	42"	30.5"-43.5"
ELS7191-EJA	ELS6191-EJA	4 jr. straight round adj. legs	42"	21.25"-34.25"
ELO7192-ADJ	ELO6192-ADJ	4 adj. legs	48"	26"-31"
ELO7192-EJA	ELO6192-EJA	4 jr. adj. legs	48"	21.25"-26.25"
ELR7192-ADJ	ELR6192-ADJ	4 curved round adj. legs	48"	26.25"-31.25"
ELR7192-EJA	ELR6192-EJA	4 jr. curved round adj. legs	48"	22.25"-27.25"
ELS7192-ADJ	ELS6192-ADJ	4 straight round adj. legs	48"	30.5"-43.5"
ELS7192-EJA	ELS6192-EJA	4 jr. straight round adj. legs	48"	21.25"-34.25"
ELO7194-ADJ	ELO6194-ADJ	4 adj. legs	60"	26"-31"
ELO7194-EJA	ELO6194-EJA	4 jr. adj. legs	60"	21.25"-26.25"
ELR7194-ADJ	ELR6194-ADJ	4 curved round adj. legs	60"	26.25"-31.25"
ELR7194-EJA	ELR6194-EJA	4 jr. curved round adj. legs	60"	22.25"-27.25"
ELS7194-ADJ	ELS6194-ADJ	4 straight round adj. legs	60"	30.5"-43.5"
ELS7194-EJA	ELS6194-EJA	4 jr. straight round adj. legs	60"	21.25"-34.25"



ELO6191-ADJ

ELO® Trapezoid Tables

<i>AE Top</i>	<i>3MM Top</i>	<i>Description</i>	<i>Top DxL</i>	<i>Table H</i>
ELO7212-ADJ	ELO6212-ADJ	4 adj. legs	24" x 48"	26"-31"
ELO7212-EJA	ELO6212-EJA	4 jr. adj. legs	24" x 48"	21.25"-26.25"
ELR7212-ADJ	ELR6212-ADJ	4 curved round adj. legs	24" x 48"	26.25"-31.25"
ELR7212-EJA	ELR6212-EJA	4 jr. curved round adj. legs	24" x 48"	22.25"-27.25"
ELS7212-ADJ	ELS6212-ADJ	4 straight round adj. legs	24" x 48"	30.5"-43.5"
ELS7212-EJA	ELS6212-EJA	4 jr. straight round adj. legs	24" x 48"	21.25"-34.25"
ELO7211-ADJ	ELO6211-ADJ	4 adj. legs	30" x 60"	26"-31"
ELO7211-EJA	ELO6211-EJA	4 jr. adj. legs	30" x 60"	21.25"-26.25"
ELR7211-ADJ	ELR6211-ADJ	4 curved round adj. legs	30" x 60"	26.25"-31.25"
ELR7211-EJA	ELR6211-EJA	4 jr. curved round adj. legs	30" x 60"	22.25"-27.25"
ELS7211-ADJ	ELS6211-ADJ	4 straight round adj. legs	30" x 60"	30.5"-43.5"
ELS7211-EJA	ELS6211-EJA	4 jr. straight round adj. legs	30" x 60"	21.25"-34.25"



ELO6211-ADJ

ELO® Table

ELO® Kidney Tables

<i>AE Top</i>	<i>3MM Top</i>	<i>Description</i>	<i>Top DxL</i>	<i>Table H</i>
ELO7223-ADJ	ELO6223-ADJ	4 adj. legs	36" x 72"	26"-31"
ELO7223-EJA	ELO6223-EJA	4 jr. adj. legs	36" x 72"	21.25"-26.25"
ELR7223-ADJ	ELR6223-ADJ	4 curved round adj. legs	36" x 72"	26.25"-31.25"
ELR7223-EJA	ELR6223-EJA	4 jr. curved round adj. legs	36" x 72"	22.25"-27.25"
ELS7223-ADJ	ELS6223-ADJ	4 straight round adj. legs	36" x 72"	30.5"-43.5"
ELS7223-EJA	ELS6223-EJA	4 jr. straight round adj. legs	36" x 72"	21.25"-34.25"
ELO7225-ADJ	ELO6225-ADJ	4 adj. legs	36" x 72"	26"-31"
ELO7225-EJA	ELO6225-EJA	4 jr. adj. legs	36" x 72"	21.25"-26.25"
ELR7225-ADJ	ELR6225-ADJ	4 curved round adj. legs	36" x 72"	26.25"-31.25"
ELR7225-EJA	ELR6225-EJA	4 jr. curved round adj. legs	36" x 72"	22.25"-27.25"
ELS7225-ADJ	ELS6225-ADJ	4 straight round adj. legs	36" x 72"	30.5"-43.5"
ELS7225-EJA	ELS6225-EJA	4 jr. straight round adj. legs	36" x 72"	21.25"-34.25"
ELO7220-ADJ	ELO6220-ADJ	4 adj. legs	48" x 72"	26"-31"
ELO7220-EJA	ELO6220-EJA	4 jr. adj. legs	48" x 72"	21.25"-26.25"
ELR7220-ADJ	ELR6220-ADJ	4 curved round adj. legs	48" x 72"	26.25"-31.25"
ELR7220-EJA	ELR6220-EJA	4 jr. curved round adj. legs	48" x 72"	22.25"-27.25"
ELS7220-ADJ	ELS6220-ADJ	4 straight round adj. legs	48" x 72"	30.5"-43.5"
ELS7220-EJA	ELS6220-EJA	4 jr. straight round adj. legs	48" x 72"	21.25"-34.25"
ELO7221-ADJ	ELO6221-ADJ	4 adj. legs	48" x 96"	26"-31"
ELO7221-EJA	ELO6221-EJA	4 jr. adj. legs	48" x 96"	21.25"-26.25"
ELR7221-ADJ	ELR6221-ADJ	4 curved round adj. legs	48" x 96"	26.25"-31.25"
ELR7221-EJA	ELR6221-EJA	4 jr. curved round adj. legs	48" x 96"	22.25"-27.25"
ELS7221-ADJ	ELS6221-ADJ	4 straight round adj. legs	48" x 96"	30.5"-43.5"
ELS7221-EJA	ELS6221-EJA	4 jr. straight round adj. legs	48" x 96"	21.25"-34.25"



ELO6223-ADJ



ELO6225-ADJ

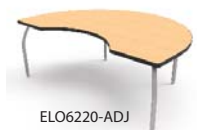

ELO6220-ADJ



ELO6221-ADJ

ELO® Clover Tables

<i>AE Top</i>	<i>3MM Top</i>	<i>Description</i>	<i>Top Dia.</i>	<i>Table H</i>
ELO7250-ADJ	ELO6250-ADJ	4 adj. legs	48"	26"-31"
ELO7250-EJA	ELO6250-EJA	4 jr. adj. legs	48"	21.25"-26.25"
ELR7250-ADJ	ELR6250-ADJ	4 curved round adj. legs	48"	26.25"-31.25"
ELR7250-EJA	ELR6250-EJA	4 jr. curved round adj. legs	48"	22.25"-27.25"
ELS7250-ADJ	ELS6250-ADJ	4 straight round adj. legs	48"	30.5"-43.5"
ELS7250-EJA	ELS6250-EJA	4 jr. straight round adj. legs	48"	21.25"-34.25"



ELO7250-ADJ

ELO® Flower Tables

<i>AE Top</i>	<i>3MM Top</i>	<i>Description</i>	<i>Top Dia.</i>	<i>Table H</i>
ELO7255-ADJ	ELO6255-ADJ	4 adj. legs	60"	26"-31"
ELO7255-EJA	ELO6255-EJA	4 jr. adj. legs	60"	21.25"-26.25"
ELR7255-ADJ	ELR6255-ADJ	4 curved round adj. legs	60"	26.25"-31.25"
ELR7255-EJA	ELR6255-EJA	4 jr. curved round adj. legs	60"	22.25"-27.25"
ELS7255-ADJ	ELS6255-ADJ	4 straight round adj. legs	60"	30.5"-43.5"
ELS7255-EJA	ELS6255-EJA	4 jr. straight round adj. legs	60"	21.25"-34.25"



ELO6255-ADJ

ELO® Table

ELO® Horseshoe and Reader Tables

<i>AE Top</i>	<i>3MM Top</i>	<i>Description</i>	<i>Top DxL</i>	<i>Table H</i>	
ELO7226-ADJ	ELO6226-ADJ	4 adj. legs	48" x 72"	26"-31"	 <p>ELO6226-ADJ</p>
ELO7226-EJA	ELO6226-EJA	4 jr. adj. legs	48" x 72"	21.25"-26.25"	
ELR7226-ADJ	ELR6226-ADJ	4 curved round adj. legs	48" x 72"	26.25"-31.25"	
ELR7226-EJA	ELR6226-EJA	4 jr. curved round adj. legs	48" x 72"	22.25"-27.25"	
ELS7226-ADJ	ELS6226-ADJ	4 straight round adj. legs	48" x 72"	30.5"-43.5"	
ELS7226-EJA	ELS6226-EJA	4 jr. straight round adj. legs	48" x 72"	21.25"-34.25"	
ELO7244-ADJ	ELO6244-ADJ	5 adj. legs	36" x 72"	26"-31"	 <p>ELO6244-ADJ</p>
ELO7244-EJA	ELO6244-EJA	5 jr. adj. legs	36" x 72"	21.25"-26.25"	
ELR7244-ADJ	ELR6244-ADJ	5 curved round adj. legs	36" x 72"	26.25"-31.25"	
ELR7244-EJA	ELR6244-EJA	5 jr. curved round adj. legs	36" x 72"	22.25"-27.25"	
ELS7244-ADJ	ELS6244-ADJ	5 straight round adj. legs	36" x 72"	30.5"-43.5"	
ELS7244-EJA	ELS6244-EJA	5 jr. straight round adj. legs	36" x 72"	21.25"-34.25"	
ELO7245-ADJ	ELO6245-ADJ	4 adj. legs	48" x 72"	26"-31"	 <p>ELO6245-ADJ</p>
ELO7245-EJA	ELO6245-EJA	4 jr. adj. legs	48" x 72"	21.25"-26.25"	
ELR7245-ADJ	ELR6245-ADJ	4 curved round adj. legs	48" x 72"	26.25"-31.25"	
ELR7245-EJA	ELR6245-EJA	4 jr. curved round adj. legs	48" x 72"	22.25"-27.25"	
ELS7245-ADJ	ELS6245-ADJ	4 straight round adj. legs	48" x 72"	30.5"-43.5"	
ELS7245-EJA	ELS6245-EJA	4 jr. straight round adj. legs	48" x 72"	21.25"-34.25"	
ELO7241-ADJ	ELO6241-ADJ	5 adj. legs	66" x 60"	26"-31"	 <p>ELO6241-ADJ</p>
ELO7241-EJA	ELO6241-EJA	5 jr. adj. legs	66" x 60"	21.25"-26.25"	
ELR7241-ADJ	ELR6241-ADJ	5 curved round adj. legs	66" x 60"	26.25"-31.25"	
ELR7241-EJA	ELR6241-EJA	5 jr. curved round adj. legs	66" x 60"	22.25"-27.25"	
ELS7241-ADJ	ELS6241-ADJ	5 straight round adj. legs	66" x 60"	30.5"-43.5"	
ELS7241-EJA	ELS6241-EJA	5 jr. straight round adj. legs	66" x 60"	21.25"-34.25"	
ELO7240-ADJ	ELO6240-ADJ	5 adj. legs	66" x 60"	26"-31"	 <p>ELO6240-ADJ</p>
ELO7240-EJA	ELO6240-EJA	5 jr. adj. legs	66" x 60"	21.25"-26.25"	
ELR7240-ADJ	ELR6240-ADJ	5 curved round adj. legs	66" x 60"	26.25"-31.25"	
ELR7240-EJA	ELR6240-EJA	5 jr. curved round adj. legs	66" x 60"	22.25"-27.25"	
ELS7240-ADJ	ELS6240-ADJ	5 straight round adj. legs	66" x 60"	30.5"-43.5"	
ELS7240-EJA	ELS6240-EJA	5 jr. straight round adj. legs	66" x 60"	21.25"-34.25"	
ELO7242-ADJ	ELO6242-ADJ	5 adj. legs	66" x 60"	26"-31"	 <p>ELO6242-ADJ</p>
ELO7242-EJA	ELO6242-EJA	5 jr. adj. legs	66" x 60"	21.25"-26.25"	
ELR7242-ADJ	ELR6242-ADJ	5 curved round adj. legs	66" x 60"	26.25"-31.25"	
ELR7242-EJA	ELR6242-EJA	5 jr. curved round adj. legs	66" x 60"	22.25"-27.25"	
ELS7242-ADJ	ELS6242-ADJ	5 straight round adj. legs	66" x 60"	30.5"-43.5"	
ELS7242-EJA	ELS6242-EJA	5 jr. straight round adj. legs	66" x 60"	21.25"-34.25"	



We Can.

DESIGN. BUILD. DELIVER.

Collaboration and group work is easier, more comfortable and contemporary with Elo® Collaborative Tables. The students will enjoy the fun shapes and quick transformation of the classroom, and the teachers will love the ease of grouping work areas.

Ask our Customer Service Team today how Elo® Collaborative Tables can help shape up your classroom.

Campostella Public Schools, VA

ELO® Table

ELO® Rectangle Tables

ELO® Square Legs		ELO® 2" Curved Round Legs		ELO® 2" Straight Round Legs		Description	Top DxD
AE Top	3MM Top	AE Top	3MM Top	AE Top	3MM Top		
ELO7065-ADJ	ELO6065-ADJ	ELR7065-ADJ	ELR6065-ADJ	ELS7065-ADJ	ELS6065-ADJ	(4 legs)	24" x 24"
ELO7065-EJA	ELO6065-EJA	ELR7065-EJA	ELR6065-EJA	ELS7065-EJA	ELS6065-EJA	(4 legs)	24" x 24"
ELO7066-ADJ	ELO6066-ADJ	ELR7066-ADJ	ELR6066-ADJ	ELS7066-ADJ	ELS6066-ADJ	(4 legs)	24" x 30"
ELO7066-EJA	ELO6066-EJA	ELR7066-EJA	ELR6066-EJA	ELS7066-EJA	ELS6066-EJA	(4 legs)	24" x 30"
ELO7067-ADJ	ELO6067-ADJ	ELR7067-ADJ	ELR6067-ADJ	ELS7067-ADJ	ELS6067-ADJ	(4 legs)	24" x 36"
ELO7067-EJA	ELO6067-EJA	ELR7067-EJA	ELR6067-EJA	ELS7067-EJA	ELS6067-EJA	(4 legs)	24" x 36"
ELO7068-ADJ	ELO6068-ADJ	ELR7068-ADJ	ELR6068-ADJ	ELS7068-ADJ	ELS6068-ADJ	(4 legs)	24" x 42"
ELO7068-EJA	ELO6068-EJA	ELR7068-EJA	ELR6068-EJA	ELS7068-EJA	ELS6068-EJA	(4 legs)	24" x 42"
ELO7069-ADJ	ELO6069-ADJ	ELR7069-ADJ	ELR6069-ADJ	ELS7069-ADJ	ELS6069-ADJ	(4 legs)	24" x 48"
ELO7069-EJA	ELO6069-EJA	ELR7069-EJA	ELR6069-EJA	ELS7069-EJA	ELS6069-EJA	(4 legs)	24" x 48"
ELO7070-ADJ	ELO6070-ADJ	ELR7070-ADJ	ELR6070-ADJ	ELS7070-ADJ	ELS6070-ADJ	(4 legs)	24" x 54"
ELO7070-EJA	ELO6070-EJA	ELR7070-EJA	ELR6070-EJA	ELS7070-EJA	ELS6070-EJA	(4 legs)	24" x 54"
ELO7071-ADJ	ELO6071-ADJ	ELR7071-ADJ	ELR6071-ADJ	ELS7071-ADJ	ELS6071-ADJ	(4 legs)	24" x 60"
ELO7071-EJA	ELO6071-EJA	ELR7071-EJA	ELR6071-EJA	ELS7071-EJA	ELS6071-EJA	(4 legs)	24" x 60"
ELO7072-ADJ	ELO6072-ADJ	ELR7072-ADJ	ELR6072-ADJ	ELS7072-ADJ	ELS6072-ADJ	(4 legs) stretcher	24" x 72"
ELO7072-EJA	ELO6072-EJA	ELR7072-EJA	ELR6072-EJA	ELS7072-EJA	ELS6072-EJA	(4 legs) stretcher	24" x 72"
ELO7073-ADJ	ELO6073-ADJ	ELR7073-ADJ	ELR6073-ADJ	ELS7073-ADJ	ELS6073-ADJ	(6 legs)	24" x 84"
ELO7073-EJA	ELO6073-EJA	ELR7073-EJA	ELR6073-EJA	ELS7073-EJA	ELS6073-EJA	(6 legs)	24" x 84"
ELO7078-ADJ	ELO6078-ADJ	ELR7078-ADJ	ELR6078-ADJ	ELS7078-ADJ	ELS6078-ADJ	(4 legs)	30" x 36"
ELO7078-EJA	ELO6078-EJA	ELR7078-EJA	ELR6078-EJA	ELS7078-EJA	ELS6078-EJA	(4 legs)	30" x 36"
ELO7079-ADJ	ELO6079-ADJ	ELR7079-ADJ	ELR6079-ADJ	ELS7079-ADJ	ELS6079-ADJ	(4 legs)	30" x 42"
ELO7079-EJA	ELO6079-EJA	ELR7079-EJA	ELR6079-EJA	ELS7079-EJA	ELS6079-EJA	(4 legs)	30" x 42"
ELO7080-ADJ	ELO6080-ADJ	ELR7080-ADJ	ELR6080-ADJ	ELS7080-ADJ	ELS6080-ADJ	(4 legs)	30" x 48"
ELO7080-EJA	ELO6080-EJA	ELR7080-EJA	ELR6080-EJA	ELS7080-EJA	ELS6080-EJA	(4 legs)	30" x 48"
ELO7082-ADJ	ELO6082-ADJ	ELR7082-ADJ	ELR6082-ADJ	ELS7082-ADJ	ELS6082-ADJ	(4 legs)	30" x 60"
ELO7082-EJA	ELO6082-EJA	ELR7082-EJA	ELR6082-EJA	ELS7082-EJA	ELS6082-EJA	(4 legs)	30" x 60"
ELO7083-ADJ	ELO6083-ADJ	ELR7083-ADJ	ELR6083-ADJ	ELS7083-ADJ	ELS6083-ADJ	(4 legs) stretcher	30" x 72"
ELO7083-EJA	ELO6083-EJA	ELR7083-EJA	ELR6083-EJA	ELS7083-EJA	ELS6083-EJA	(4 legs) stretcher	30" x 72"
ELO7084-ADJ	ELO6084-ADJ	ELR7084-ADJ	ELR6084-ADJ	ELS7084-ADJ	ELS6084-ADJ	(6 legs)	30" x 84"
ELO7084-EJA	ELO6084-EJA	ELR7084-EJA	ELR6084-EJA	ELS7084-EJA	ELS6084-EJA	(6 legs)	30" x 84"
ELO7085-ADJ	ELO6085-ADJ	ELR7085-ADJ	ELR6085-ADJ	ELS7085-ADJ	ELS6085-ADJ	(6 legs)	30" x 96"
ELO7085-EJA	ELO6085-EJA	ELR7085-EJA	ELR6085-EJA	ELS7085-EJA	ELS6085-EJA	(6 legs)	30" x 96"

ELO® 1.25" Square Legs

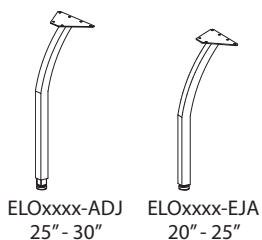

ELO® 2" Curved Round Legs

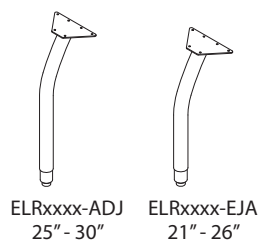

ELO® 2" Straight Round Legs

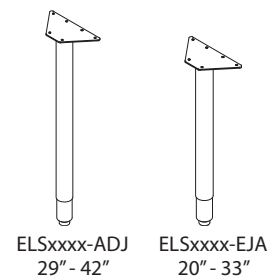

ELO® Table

ELO® Rectangle Tables

ELO® Square Legs		ELO® 2" Curved Round Legs		ELO® 2" Straight Round Legs		Description	Top DxDL
AE Top	3MM Top	AE Top	3MM Top	AE Top	3MM Top		
ELO7088-ADJ	ELO6088-ADJ	ELR7088-ADJ	ELR6088-ADJ	ELS7088-ADJ	ELS6088-ADJ	(4 legs)	36" x 36"
ELO7088-EJA	ELO6088-EJA	ELR7088-EJA	ELR6088-EJA	ELS7088-EJA	ELS6088-EJA	(4 legs)	36" x 36"
ELO7089-ADJ	ELO6089-ADJ	ELR7089-ADJ	ELR6089-ADJ	ELS7089-ADJ	ELS6089-ADJ	(4 legs)	36" x 42"
ELO7089-EJA	ELO6089-EJA	ELR7089-EJA	ELR6089-EJA	ELS7089-EJA	ELS6089-EJA	(4 legs)	36" x 42"
ELO7090-ADJ	ELO6090-ADJ	ELR7090-ADJ	ELR6090-ADJ	ELS7090-ADJ	ELS6090-ADJ	(4 legs)	36" x 48"
ELO7090-EJA	ELO6090-EJA	ELR7090-EJA	ELR6090-EJA	ELS7090-EJA	ELS6090-EJA	(4 legs)	36" x 48"
ELO7092-ADJ	ELO6092-ADJ	ELR7092-ADJ	ELR6092-ADJ	ELS7092-ADJ	ELS6092-ADJ	(4 legs)	36" x 60"
ELO7092-EJA	ELO6092-EJA	ELR7092-EJA	ELR6092-EJA	ELS7092-EJA	ELS6092-EJA	(4 legs)	36" x 60"
ELO7093-ADJ	ELO6093-ADJ	ELR7093-ADJ	ELR6093-ADJ	ELS7093-ADJ	ELS6093-ADJ	(4 legs) stretcher	36" x 72"
ELO7093-EJA	ELO6093-EJA	ELR7093-EJA	ELR6093-EJA	ELS7093-EJA	ELS6093-EJA	(4 legs) stretcher	36" x 72"
ELO7094-ADJ	ELO6094-ADJ	ELR7094-ADJ	ELR6094-ADJ	ELS7094-ADJ	ELS6094-ADJ	(6 legs)	36" x 84"
ELO7094-EJA	ELO6094-EJA	ELR7094-EJA	ELR6094-EJA	ELS7094-EJA	ELS6094-EJA	(6 legs)	36" x 84"
ELO7095-ADJ	ELO6095-ADJ	ELR7095-ADJ	ELR6095-ADJ	ELS7095-ADJ	ELS6095-ADJ	(6 legs)	36" x 96"
ELO7095-EJA	ELO6095-EJA	ELR7095-EJA	ELR6095-EJA	ELS7095-EJA	ELS6095-EJA	(6 legs)	36" x 96"
ELO7098-ADJ	ELO6098-ADJ	ELR7098-ADJ	ELR6098-ADJ	ELS7098-ADJ	ELS6098-ADJ	(4 legs)	42" x 42"
ELO7098-EJA	ELO6098-EJA	ELR7098-EJA	ELR6098-EJA	ELS7098-EJA	ELS6098-EJA	(4 legs)	42" x 42"
ELO7120-ADJ	ELO6120-ADJ	ELR7120-ADJ	ELR6120-ADJ	ELS7120-ADJ	ELS6120-ADJ	(4 legs)	42" x 50"
ELO7120-EJA	ELO6120-EJA	ELR7120-EJA	ELR6120-EJA	ELS7120-EJA	ELS6120-EJA	(4 legs)	42" x 50"
ELO7099-ADJ	ELO6099-ADJ	ELR7099-ADJ	ELR6099-ADJ	ELS7099-ADJ	ELS6099-ADJ	(4 legs)	42" x 60"
ELO7099-EJA	ELO6099-EJA	ELR7099-EJA	ELR6099-EJA	ELS7099-EJA	ELS6099-EJA	(4 legs)	42" x 60"
ELO7100-ADJ	ELO6100-ADJ	ELR7100-ADJ	ELR6100-ADJ	ELS7100-ADJ	ELS6100-ADJ	(4 legs) stretcher	42" x 72"
ELO7100-EJA	ELO6100-EJA	ELR7100-EJA	ELR6100-EJA	ELS7100-EJA	ELS6100-EJA	(4 legs) stretcher	42" x 72"
ELO7107-ADJ	ELO6107-ADJ	ELR7107-ADJ	ELR6107-ADJ	ELS7107-ADJ	ELS6107-ADJ	(4 legs)	48" x 48"
ELO7107-EJA	ELO6107-EJA	ELR7107-EJA	ELR6107-EJA	ELS7107-EJA	ELS6107-EJA	(4 legs)	48" x 48"
ELO7108-ADJ	ELO6108-ADJ	ELR7108-ADJ	ELR6108-ADJ	ELS7108-ADJ	ELS6108-ADJ	(4 legs)	48" x 60"
ELO7108-EJA	ELO6108-EJA	ELR7108-EJA	ELR6108-EJA	ELS7108-EJA	ELS6108-EJA	(4 legs)	48" x 60"
ELO7109-ADJ	ELO6109-ADJ	ELR7109-ADJ	ELR6109-ADJ	ELS7109-ADJ	ELS6109-ADJ	(4 legs) stretcher	48" x 72"
ELO7109-EJA	ELO6109-EJA	ELR7109-EJA	ELR6109-EJA	ELS7109-EJA	ELS6109-EJA	(4 legs) stretcher	48" x 72"
ELO7111-ADJ	ELO6111-ADJ	ELR7111-ADJ	ELR6111-ADJ	ELS7111-ADJ	ELS6111-ADJ	(6 legs)	48" x 96"
ELO7111-EJA	ELO6111-EJA	ELR7111-EJA	ELR6111-EJA	ELS7111-EJA	ELS6111-EJA	(6 legs)	48" x 96"



ELO® Mini Nimbus

ELO® Connect 4

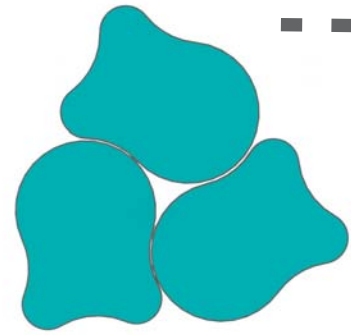

ELO®

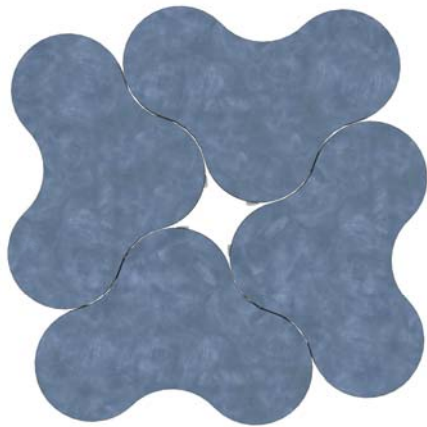

ELO® Adapt



desk

ELO®
Mini Tide

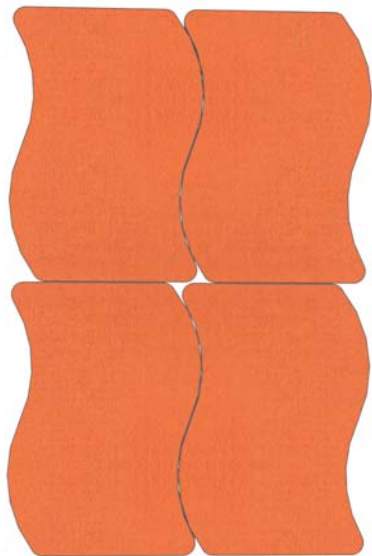

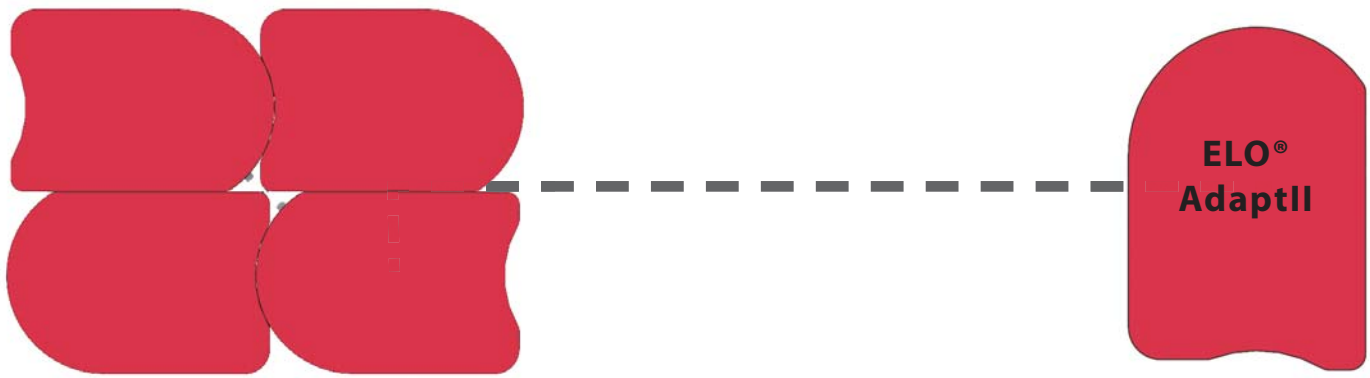

shapes

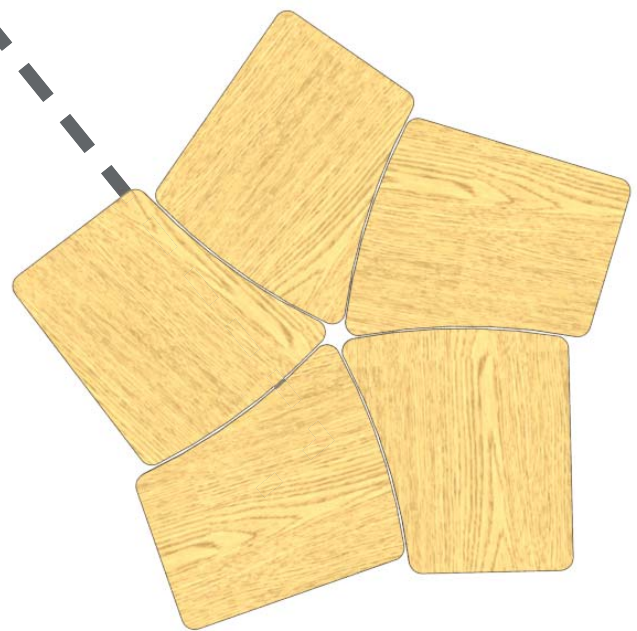

ELO® Desk Tops

What's in a Shape?

Not only does the shape of a desk top allow for simple connecting of units, but each different shape allows for better arrangement of materials on the work surface. Understanding how a desk top will be used in a classroom is critical in determining what size and shape desk top to select. With the wider space positioned closer to the student, notebooks and laptops are easy to reach. Place the wider space opposite the student and this creates a generous workspace for shared projects. Let WB Manufacturing get you into shape.

ELO® Desk

ELO® Connect 4 Desks



AE Top	3MM Top	Description	Top DxD	Desk H
ELO7400-ADJ	ELO6400-ADJ	3 adj. legs	24" x 36"	26"-31"
ELO7400-EJA	ELO6400-EJA	3 jr. adj. legs	24" x 36"	21.25"-26.25"
ELO7400-ADJSU	ELO6400-ADJSU	StandUp, 3 adj. legs	24" x 36"	33.5"-43.5"
ELR7400-ADJ	ELR6400-ADJ	3 curved round adj. legs	24" x 36"	26.25"-31.25"
ELR7400-EJA	ELR6400-EJA	3 jr. curved round adj. legs	24" x 36"	22.25"-27.25"
ELS7400-ADJ	ELS6400-ADJ	Sit to Stand, 3 straight round adj. legs	24" x 36"	30.5"-43.5"
ELS7400-EJA	ELS6400-EJA	Sit to Stand, 3 jr. straight round adj. legs	24" x 36"	21.25"-34.25"



ELO6400-ADJ

ELO® Connect 6 Desks



AE Top	3MM Top	Description	Top DxD	Desk H
ELO7216-ADJ	ELO6216-ADJ	4 adj. legs	18" x 30"	26"-31"
ELO7216-EJA	ELO6216-EJA	4 jr. adj. legs	18" x 30"	21.25"-26.25"
ELO7216-ADJSU	ELO6216-ADJSU	StandUp, 4 adj. legs	18" x 30"	33.5"-43.5"
ELR7216-ADJ	ELR6216-ADJ	4 curved round adj. legs	18" x 30"	26.25"-31.25"
ELR7216-EJA	ELR6216-EJA	4 jr. curved round adj. legs	18" x 30"	22.25"-27.25"
ELS7216-ADJ	ELS6216-ADJ	Sit to Stand, 4 straight round adj. legs	18" x 30"	30.5"-43.5"
ELS7216-EJA	ELS6216-EJA	Sit to Stand, 4 jr. straight round adj. legs	18" x 30"	21.25"-34.25"



ELO6216-ADJ

ELO® Connect 8 Desks



AE Top	3MM Top	Description	Top DxD	Desk H
ELO7217-ADJ	ELO6217-ADJ	4 adj. legs	24" x 33"	26"-31"
ELO7217-EJA	ELO6217-EJA	4 jr. adj. legs	24" x 33"	21.25"-26.25"
ELO7217-ADJSU	ELO6217-ADJSU	StandUp, 4 adj. legs	24" x 33"	33.5"-43.5"
ELR7217-ADJ	ELR6217-ADJ	4 curved round adj. legs	24" x 33"	26.25"-31.25"
ELR7217-EJA	ELR6217-EJA	4 jr. curved round adj. legs	24" x 33"	22.25"-27.25"
ELS7217-ADJ	ELS6217-ADJ	Sit to Stand, 4 straight round adj. legs	24" x 33"	30.5"-43.5"
ELS7217-EJA	ELS6217-EJA	Sit to Stand, 4 jr. straight round adj. legs	24" x 33"	21.25"-34.25"



ELO6217-ADJ

ELO® Diamond Desks



AE Top	3MM Top	Description	Top DxD	Desk H
ELO7318-ADJ	ELO6318-ADJ	3 adj. legs	30" x 34"	26"-31"
ELO7318-EJA	ELO6318-EJA	3 jr. adj. legs	30" x 34"	21.25"-26.25"
ELO7318-ADJSU	ELO6318-ADJSU	StandUp, 3 adj. legs	30" x 34"	33.5"-43.5"
ELR7318-ADJ	ELR6318-ADJ	3 curved round adj. legs	30" x 34"	26.25"-31.25"
ELR7318-EJA	ELR6318-EJA	3 jr. curved round adj. legs	30" x 34"	22.25"-27.25"
ELS7318-ADJ	ELS6318-ADJ	Sit to Stand, 3 straight round adj. legs	30" x 34"	30.5"-43.5"
ELS7318-EJA	ELS6318-EJA	Sit to Stand, 3 jr. straight round adj. legs	30" x 34"	21.25"-34.25"



ELO6318-ADJ

ELO® Ocho Desks



<i>AE Top</i>	<i>3MM Top</i>	<i>Description</i>	<i>Top DxD</i>	<i>Desk H</i>
ELO7500-ADJ	ELO6500-ADJ	4 adj. legs	20" x 36"	26"-31"
ELO7500-EJA	ELO6500-EJA	4 jr. adj. legs	20" x 36"	21.25"-26.25"
ELO7500-ADJSU	ELO6500-ADJSU	StandUp, 4 adj. legs	20" x 36"	33.5"-43.5"
ELR7500-ADJ	ELR6500-ADJ	4 curved round adj. legs	20" x 36"	26.25"-31.25"
ELR7500-EJA	ELR6500-EJA	4 jr. curved round adj. legs	20" x 36"	22.25"-27.25"
ELS7500-ADJ	ELS6500-ADJ	Sit to Stand, 4 straight round adj. legs	20" x 36"	30.5"-43.5"
ELS7500-EJA	ELS6500-EJA	Sit to Stand, 4 jr. straight round adj. legs	20" x 36"	21.25"-34.25"



ELO® Plymouth II Desks



<i>AE Top</i>	<i>3MM Top</i>	<i>Description</i>	<i>Top DxD</i>	<i>Desk H</i>
ELO7171-ADJ	ELO6171-ADJ	4 adj. legs	20" x 27.5"	26"-31"
ELO7171-EJA	ELO6171-EJA	4 jr. adj. legs	20" x 27.5"	21.25"-26.25"
ELO7171-ADJSU	ELO6171-ADJSU	StandUp, 4 adj. legs	20" x 27.5"	33.5"-43.5"
ELR7171-ADJ	ELR6171-ADJ	4 curved round adj. legs	20" x 27.5"	26.25"-31.25"
ELR7171-EJA	ELR6171-EJA	4 jr. curved round adj. legs	20" x 27.5"	22.25"-27.25"
ELS7171-ADJ	ELS6171-ADJ	Sit to Stand, 4 straight round adj. legs	20" x 28"	30.5"-43.5"
ELS7171-EJA	ELS6171-EJA	Sit to Stand, 4 jr. straight round adj. legs	20" x 28"	21.25"-34.25"



ELO® Plymouth II-XL Desks



<i>AE Top</i>	<i>3MM Top</i>	<i>Description</i>	<i>Top DxD</i>	<i>Desk H</i>
ELO7173-ADJ	ELO6173-ADJ	4 adj. legs	24" x 36"	26"-31"
ELO7173-EJA	ELO6173-EJA	4 jr. adj. legs	24" x 36"	21.25"-26.25"
ELO7173-ADJSU	ELO6173-ADJSU	StandUp, 4 adj. legs	24" x 36"	33.5"-43.5"
ELR7173-ADJ	ELR6173-ADJ	4 curved round adj. legs	24" x 36"	26.25"-31.25"
ELR7173-EJA	ELR6173-EJA	4 jr. curved round adj. legs	24" x 36"	22.25"-27.25"
ELS7173-ADJ	ELS6173-ADJ	Sit to Stand, 4 straight round adj. legs	24" x 36"	30.5"-43.5"
ELS7173-EJA	ELS6173-EJA	Sit to Stand, 4 jr. straight round adj. legs	24" x 36"	21.25"-34.25"



ELO® Plymouth Desks



<i>AE Top</i>	<i>3MM Top</i>	<i>Description</i>	<i>Top DxD</i>	<i>Desk H</i>
ELO7174-ADJ	ELO6174-ADJ	4 adj. legs	20" x 27.5"	26"-31"
ELO7174-EJA	ELO6174-EJA	4 jr. adj. legs	20" x 27.5"	21.25"-26.25"
ELO7174-ADJSU	ELO6174-ADJSU	StandUp, 4 adj. legs	20" x 27.5"	33.5"-43.5"
ELR7174-ADJ	ELR6174-ADJ	4 curved round adj. legs	20" x 27.5"	26.25"-31.25"
ELR7174-EJA	ELR6174-EJA	4 jr. curved round adj. legs	20" x 27.5"	22.25"-27.25"
ELS7174-ADJ	ELS6174-ADJ	Sit to Stand, 4 straight round adj. legs	20" x 28"	30.5"-43.5"
ELS7174-EJA	ELS6174-EJA	Sit to Stand, 4 jr. straight round adj. legs	20" x 28"	21.25"-34.25"



ELO® Desk

ELO® Adapt Desks

<i>AE Top</i>	<i>3MM Top</i>	<i>Description</i>	<i>Top DxL</i>	<i>Desk H</i>
ELO7600-ADJ	ELO6600-ADJ	4 adj. legs	22.5" x 30"	26"-31"
ELO7600-EJA	ELO6600-EJA	4 jr. adj. legs	22.5" x 30"	21.25"-26.25"
ELO7600-ADJSU	ELO6600-ADJSU	StandUp, 4 adj. legs	22.5" x 30"	33.5"-43.5"
ELR7600-ADJ	ELR6600-ADJ	4 curved round adj. legs	22.5" x 30"	26.25"-31.25"
ELR7600-EJA	ELR6600-EJA	4 jr. curved round adj. legs	22.5" x 30"	22.25"-27.25"
N/A	N/A	Sit to Stand, 4 straight round adj. legs	N/A	N/A
N/A	N/A	Sit to Stand, 4 jr. straight round adj. legs	N/A	N/A



ELO7600-ADJ

ELO® Adapt XL Desks

<i>AE Top</i>	<i>3MM Top</i>	<i>Description</i>	<i>Top DxL</i>	<i>Desk H</i>
ELO7601-ADJ	ELO6601-ADJ	4 adj. legs	22.5" x 33"	26"-31"
ELO7601-EJA	ELO6601-EJA	4 jr. adj. legs	22.5" x 33"	21.25"-26.25"
ELO7601-ADJSU	ELO6601-ADJSU	StandUp, 4 adj. legs	22.5" x 33"	33.5"-43.5"
ELR7601-ADJ	ELR6601-ADJ	4 curved round adj. legs	22.5" x 33"	26.25"-31.25"
ELR7601-EJA	ELR6601-EJA	4 jr. curved round adj. legs	22.5" x 33"	22.25"-27.25"
ELS7601-ADJ	ELS6601-ADJ	Sit to Stand, 4 straight round adj. legs	22.5" x 33"	30.5"-43.5"
ELS7601-EJA	ELS6601-EJA	Sit to Stand, 4 jr. straight round adj. legs	22.5" x 33"	21.25"-34.25"



ELO7601-ADJ

ELO® Adapt II Desks

<i>AE Top</i>	<i>3MM Top</i>	<i>Description</i>	<i>Top DxL</i>	<i>Desk H</i>
ELO7810-ADJ	ELO6810-ADJ	4 adj. legs	21.5" x 30"	26"-31"
ELO7810-EJA	ELO6810-EJA	4 jr. adj. legs	21.5" x 30"	21.25"-26.25"
ELO7810-ADJSU	ELO6810-ADJSU	StandUp, 4 adj. legs	21.5" x 30"	33.5"-43.5"
ELR7810-ADJ	ELR6810-ADJ	4 curved round adj. legs	21.5" x 30"	26.25"-31.25"
ELR7810-EJA	ELR6810-EJA	4 jr. curved round adj. legs	21.5" x 30"	22.25"-27.25"
ELS7810-ADJ	ELS6810-ADJ	Sit to Stand, 4 straight round adj. legs	21.5" x 30"	30.5"-43.5"
ELS7810-EJA	ELS6810-EJA	Sit to Stand, 4 jr. straight round adj. legs	21.5" x 30"	21.25"-34.25"

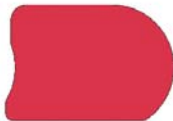

ELO6810-ADJ

ELO® Mini Nimbus Desks

<i>AE Top</i>	<i>3MM Top</i>	<i>Description</i>	<i>Top DxL</i>	<i>Desk H</i>
ELO7809-ADJ	N/A	3 adj. legs	25.5" x 36"	26"-31"
ELO7809-EJA	N/A	3 jr. adj. legs	25.5" x 36"	21.25"-26.25"
ELO7809-ADJSU	N/A	StandUp, 3 adj. legs	25.5" x 36"	33.5"-43.5"
ELR7809-ADJ	N/A	3 curved round adj. legs	25.5" x 36"	26.25"-31.25"
ELR7809-EJA	N/A	3 jr. curved round adj. legs	25.5" x 36"	22.25"-27.25"
ELS7809-ADJ	N/A	Sit to Stand, 3 straight round adj. legs	25.5" x 36"	30.5"-43.5"
ELS7809-EJA	N/A	Sit to Stand, 3 jr. straight round adj. legs	25.5" x 36"	21.25"-34.25"



ELO7809-ADJ

ELO® Arcadia Desks

<i>AE Top</i>	<i>3MM Top</i>	<i>Description</i>	<i>Top DxL</i>	<i>Desk H</i>
ELO7813-ADJ	ELO6813-ADJ	4 adj. legs	23.88" x 25.81"	26"-31"
ELO7813-EJA	ELO6813-EJA	4 jr. adj. legs	23.88" x 25.81"	21.25"-26.25"
ELO7813-ADJSU	ELO6813-ADJSU	StandUp, 4 adj. legs	23.88" x 25.81"	33.5"-43.5"
ELR7813-ADJ	ELR6813-ADJ	4 curved round adj. legs	23.88" x 25.81"	26.25"-31.25"
ELR7813-EJA	ELR6813-EJA	4 jr. curved round adj. legs	23.88" x 25.81"	22.25"-27.25"
ELS7813-ADJ	ELS6813-ADJ	Sit to Stand, 4 straight round adj. legs	26.108" x 28.669"	30.5"-43.5"
ELS7813-EJA	ELS6813-EJA	Sit to Stand, 4 jr. straight rd. adj. legs	26.108" x 28.669"	21.25"-34.25"



ELO6813-ADJ

ELO® Desk

ELO® Loyal Desks

<i>AE Top</i>	<i>3MM Top</i>	<i>Description</i>	<i>Top DxL</i>	<i>Desk H</i>
ELO7316-ADJ	ELO6316-ADJ	4 adj. legs	22" x 30"	26"-31"
ELO7316-EJA	ELO6316-EJA	4 jr. adj. legs	22" x 30"	21.25"-26.25"
ELO7316-ADJSU	ELO6316-ADJSU	StandUp, 4 adj. legs	22" x 30"	33.5"-43.5"
ELR7316-ADJ	ELR6316-ADJ	4 curved round adj. legs	22" x 30"	26.25"-31.25"
ELR7316-EJA	ELR6316-EJA	4 jr. curved round adj. legs	22" x 30"	22.25"-27.25"
ELS7316-ADJ	ELS6316-ADJ	Sit to Stand, 4 straight round adj. legs	22" x 30"	30.5"-43.5"
ELS7316-EJA	ELS6316-EJA	Sit to Stand, 4 jr. straight round adj. legs	22" x 30"	21.25"-34.25"



ELO7316-ADJ

ELO® Mini Tide Desks

<i>AE Top</i>	<i>3MM Top</i>	<i>Description</i>	<i>Top DxL</i>	<i>Desk H</i>
ELO7811-ADJ	ELO6811-ADJ	4 adj. legs	23" x 32.5"	26"-31"
ELO7811-EJA	ELO6811-EJA	4 jr. adj. legs	23" x 32.5"	21.25"-26.25"
ELO7811-ADJSU	ELO6811-ADJSU	StandUp, 4 adj. legs	23" x 32.5"	33.5"-43.5"
ELR7811-ADJ	ELR6811-ADJ	4 curved round adj. legs	23" x 32.5"	26.25"-31.25"
ELR7811-EJA	ELR6811-EJA	4 jr. curved round adj. legs	23" x 32.5"	22.25"-27.25"
ELS7811-ADJ	ELS6811-ADJ	Sit to Stand, 4 straight round adj. legs	23" x 32.5"	30.5"-43.5"
ELS7811-EJA	ELS6811-EJA	Sit to Stand, 4 jr. straight round adj. legs	23" x 32.5"	21.25"-34.25"



ELO6811-ADJ

ELO® Mini Diamond Desks

<i>AE Top</i>	<i>3MM Top</i>	<i>Description</i>	<i>Top DxL</i>	<i>Desk H</i>
ELO7317-ADJ	ELO6317-ADJ	3 adj. legs	27" x 30.5"	26"-31"
ELO7317-EJA	ELO6317-EJA	3 jr. adj. legs	27" x 30.5"	21.25"-26.25"
ELO7317-ADJSU	ELO6317-ADJSU	StandUp, 3 adj. legs	27" x 30.5"	33.5"-43.5"
ELR7317-ADJ	ELR6317-ADJ	3 curved round adj. legs	27" x 30.5"	26.25"-31.25"
ELR7317-EJA	ELR6317-EJA	3 jr. curved round adj. legs	27" x 30.5"	22.25"-27.25"
ELS7317-ADJ	ELS6317-ADJ	Sit to Stand, 3 straight round adj. legs	27" x 30.5"	30.5"-43.5"
ELS7317-EJA	ELS6317-EJA	Sit to Stand, 3 jr. straight round adj. legs	27" x 30.5"	21.25"-34.25"



ELO6317-ADJ

ELO® Pyramid Desks

<i>AE Top</i>	<i>3MM Top</i>	<i>Description</i>	<i>Top DxL</i>	<i>Desk H</i>
ELO7814-ADJ	ELO6814-ADJ	3 adj. legs	23.42" x 41.18"	26"-31"
ELO7814-EJA	ELO6814-EJA	3 jr. adj. legs	23.42" x 41.18"	21.25"-26.25"
ELO7814-ADJSU	ELO6814-ADJSU	StandUp, 3 adj. legs	23.42" x 41.18"	33.5"-43.5"
ELR7814-ADJ	ELR6814-ADJ	3 curved round adj. legs	23.42" x 41.18"	26.25"-31.25"
ELR7814-EJA	ELR6814-EJA	3 jr. curved round adj. legs	23.42" x 41.18"	22.25"-27.25"
ELS7814-ADJ	ELS6814-ADJ	Sit to Stand, 3 straight round adj. legs	23.42" x 41.18"	30.5"-43.5"
ELS7814-EJA	ELS6814-EJA	Sit to Stand, 3 jr. straight round adj. legs	23.42" x 41.18"	21.25"-34.25"



ELO6814-ADJ

ELO® Hurley Desks

<i>AE Top</i>	<i>3MM Top</i>	<i>Description</i>	<i>Top DxL</i>	<i>Desk H</i>
ELO7816-ADJ	ELO6816-ADJ	4 adj. legs	21.5" x 31"	26"-31"
ELO7816-EJA	ELO6816-EJA	4 jr. adj. legs	21.5" x 31"	21.25"-26.25"
ELO7816-ADJSU	ELO6816-ADJSU	StandUp, 4 adj. legs	21.5" x 31"	33.5"-43.5"
ELR7816-ADJ	ELR6816-ADJ	4 curved round adj. legs	21.5" x 31"	26.25"-31.25"
ELR7816-EJA	ELR6816-EJA	4 jr. curved round adj. legs	21.5" x 31"	22.25"-27.25"
ELS7816-ADJ	ELS6816-ADJ	Sit to Stand, 4 straight round adj. legs	21.5" x 31"	30.5"-43.5"
ELS7816-EJA	ELS6816-EJA	Sit to Stand, 4 jr. straight round adj. legs	21.5" x 31"	21.25"-34.25"



ELO6816-ADJ



UNE-T Desk

Durable, Comfortable, Affordable

UNE-T desk series was developed with students, teachers and budgets in mind. Choose from our Connect 8, popular Echo or Plymouth desks, 2-Student tables and workstations. These are outfitted with a universal, heavy duty steel T-Leg with welded gusset for added strength and easy assembly. Additionally, each include a stretcher bar to keep desks and tables from swaying. When it comes to no frills, quality-built desks and tables we may not be the biggest and we may not be the least expensive, but we are the best value around. Look to WB Manufacturing for quality-built products that stand the test of time.

UNE-T

UNE-T Leg

One Leg. One Mission...To Save Money.

That about sums it up. The new UNE-T desks and tables from WB Manufacturing are designed to use the same leg for both the right and left sides, saving expensive manufacturing dollars. The best part? WB is passing this savings on to you. Strong, versatile design accommodates any environment and budget. Bring unity to your classroom with our complete UNE-T series.



UNE-T Leg



UNE-T Double-T Leg



Power and media modules available. See page 50.

UNE-T Table, Workstation and Desk Overview

- Adj Legs: 15-gauge 1.25" square steel tube with 10-gauge mounting plate, 21" to 30" height in 1" increments, smooth silver finish
- StandUp Legs: 15-gauge 1.25" square steel tube with 10-gauge mounting plate, 32" to 41" height in 1" increments, only available in smooth silver finish, footrest(required and only available with black Lotz Armor Edge™)
- Double T Legs: 15-gauge 1.25" square steel tube with 10-gauge mounting plate, 21" to 30" height in 1" increments, only available in smooth silver finish
- Laminate Top: 1.25" high pressure laminate (HPL) with phenolic backer (reinforcement bar on 72"L)
- Edge Banding: Beveled Lotz Armor Edge™ (standard), 3mm PVC optional
- Ergo Front: Post-formed ergo edge on front of designated workstations, 3mm PVC on back and sides
- Finish: Standard or custom laminate
- Power: Modules for power and media (optional, with most desks)
- Optional: Dual wheel locking casters*(caster raises heights approx. 2"), 2.5" Grand Hank Glide, tote storage, book box, backpack hook (optional items available on most desk and table models)
*Casters are NOT to be used as leveling devices and requires field assembly.



Beveled edge with Lotz Armor Edge™

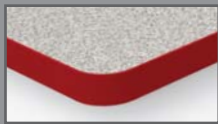

3mm PVC



Adjustable leg insert with 2 tamper resistant screws



Spanner bars available in multiple lengths



Fully welded leg mounting plate



Steel book box (optional)

HPL Standard Laminate Color Options

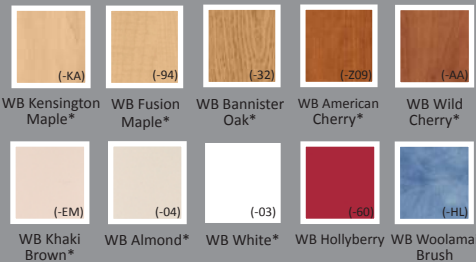

*Stocked in limited sizes & quantities. Contact Customer Service for lead time.

Frame Color Options

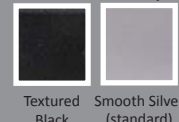

Dual wheel casters-raises height by approx. 2" (optional)



2.5" Grand Hank Glide (optional)



Complete Laminate Collections Available



Grantham Middle School, NC

UNE-T Table & Workstation

UNE-T 2-Student Tables

<i>AE Top</i>	<i>3MM Top</i>	<i>Description</i>	<i>Top DxD</i>	<i>Table H</i>
UNE7138-ADJ	UNE6138-ADJ	UNE-T 2-Student	20" x 48"	22.25"-31.25"
UNE7143-ADJ	UNE6143-ADJ	UNE-T 2-Student	20" x 54"	22.25"-31.25"
UNE7139-ADJ	UNE6139-ADJ	UNE-T 2-Student	20" x 60"	22.25"-31.25"
UNE7140-ADJ	UNE6140-ADJ	UNE-T 2-Student	20" x 72"	22.25"-31.25"
UNE7069-ADJ	UNE6069-ADJ	UNE-T 2-Student	24" x 48"	22.25"-31.25"
UNE7070-ADJ	UNE6070-ADJ	UNE-T 2-Student	24" x 54"	22.25"-31.25"
UNE7071-ADJ	UNE6071-ADJ	UNE-T 2-Student	24" x 60"	22.25"-31.25"
UNE7072-ADJ	UNE6072-ADJ	UNE-T 2-Student	24" x 72"	22.25"-31.25"
UNE7080-ADJ	UNE6080-ADJ	UNE-T 2-Student with Double T Legs	30" x 48"	22.25"-31.25"
UNE7081-ADJ	UNE6081-ADJ	UNE-T 2-Student with Double T Legs	30" x 54"	22.25"-31.25"
UNE7082-ADJ	UNE6082-ADJ	UNE-T 2-Student with Double T Legs	30" x 60"	22.25"-31.25"
UNE7083-ADJ	UNE6083-ADJ	UNE-T 2-Student with Double T Legs	30" x 72"	22.25"-31.25"



UNE-T Workstations

<i>AE Edge</i>	<i>3MM Top</i>	<i>Ergo Front</i>	<i>Description</i>	<i>Top DxD</i>	<i>Wrkstation H</i>
UWS7067-ADJ	UWS6067-ADJ	UWSE6067-ADJ	1 Grommet	24" x 36"	22.25"-31.25"
UWS7069-ADJ	UWS6069-ADJ	UWSE6069-ADJ	1 Grommet	24" x 48"	22.25"-31.25"
UWS7071-ADJ	UWS6071-ADJ	UWSE6071-ADJ	2 Grommet	24" x 60"	22.25"-31.25"
UWS7072-ADJ	UWS6072-ADJ	UWSE6072-ADJ	2 Grommet	24" x 72"	22.25"-31.25"
UWS7080-ADJ	UWS6080-ADJ	UWSE6080-ADJ	1 Grmt w/Double T Legs	30" x 48"	22.25"-31.25"
UWS7082-ADJ	UWS6082-ADJ	UWSE6082-ADJ	2 Grmt w/Double T Legs	30" x 60"	22.25"-31.25"
UWS7083-ADJ	UWS6083-ADJ	UWSE6083-ADJ	2 Grmt w/Double T Legs	30" x 72"	22.25"-31.25"

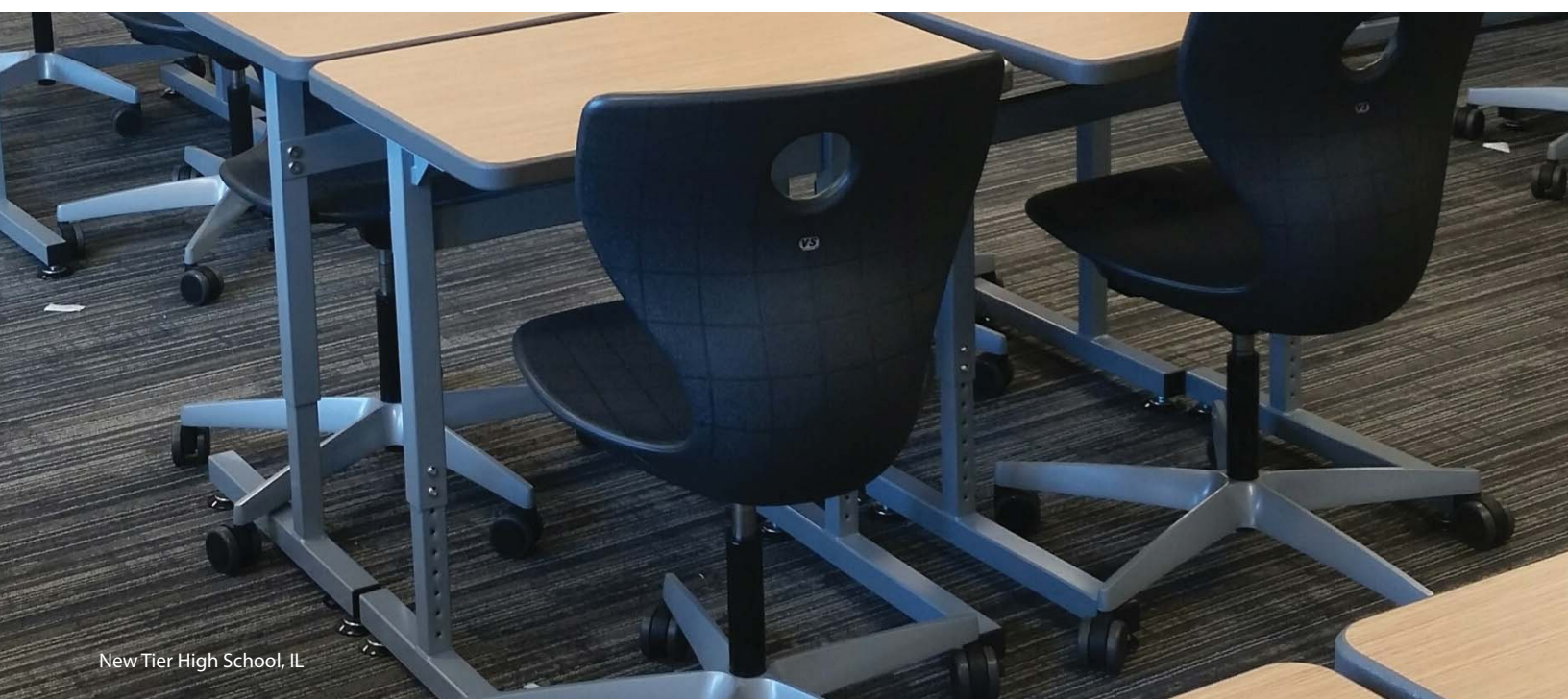

New Tier High School, IL

UNE-T Desk

UNE-T Ocho Desk



AE Top	3MM Top	Description	Top DxL	Desk H
UNE7500-ADJ	UNE6500-ADJ	UNE-T Ocho	21" x 35"	22.25"-31.25"



UNE7500-ADJ

UNE-T Connect 8 Desk



AE Top	3MM Top	Description	Top DxL	Desk H
UNE7215-ADJ	UNE6215-ADJ	UNE-T Connect 8	22" x 32.5"	22.25"-31.25"



UNE7215-ADJ

UNE-T PlymouTh Desks



AE Top	3MM Top	Description	Top DxL	Desk H
UNE7362-ADJ	UNE6362-ADJ	UNE-T PlymouTh	20" x 27"	22.25"-31.25"
UNE7362-ADJSUF	UNE6362-ADJSUF	StandUp, UNE-T PlymouTh	20" x 27"	33.25"-42.25"
UNE7064-ADJ	UNE6064-ADJ	UNE-T PlymouTh	20" x 36"	22.25"-31.25"
UNE7145-ADJ	UNE6145-ADJ	UNE-T PlymouTh	24" x 27"	22.25"-31.25"



UNE7362-ADJ

UNE-T PlymouTh XL Desk



AE Top	3MM Top	Description	Top DxL	Desk H
UNE7067-ADJ	UNE6067ADJ	UNE-T PlymouTh XL	24" x 36"	22.25"-31.25"



UNE7067-ADJ

UNE-T PlymouTh II Desk



AE Top	3MM Top	Description	Top DxL	Desk H
UNE7363-ADJ	UNE6363-ADJ	UNE-T PlymouTh II	20" x 27"	22.25"-31.25"
UNE7363-ADJSUF	UNE6363-ADJSUF	StandUp, UNE-T PlymouTh II	20" x 27"	22.25"-31.25"



UNE7363-ADJSUF

UNE-T ADA Desk*



AE Top	3MM Top	Description	Top DxL	Desk H
UNE7142-ADJ	UNE6142-ADJ	UNE-T ADA	20" x 37"	22.25"-31.25"



UNE7142-ADJ

UNE-T Adapt Desk



AE Top	3MM Top	Description	Top DxL	Desk H
UNE7610-ADJ	UNE6610-ADJ	UNE-T Adapt	24" x 36"	22.25"-31.25"



UNE7610-ADJ

*UNE-T ADA compliant desks: UNE7142 & UNE6142 ONLY



ACT7255-ALS

Activity Table

Versatile in Shape and Size

WB Manufacturing's most popular all-purpose activity table features stain and scratch resistant high pressure laminate top with a phenolic backer that prevents moisture penetration and acts as an anti-gum coating. Indestructible Lotz Armor Edge™ seals and protects table edges and will not separate from table core. Quick mount leg plates ensure easy assembly of the 14-gauge steel and chrome adjustable legs. Optional 3mm edge banding is also available.

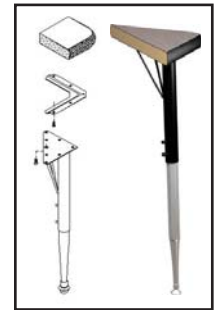

Activity

Custom Activity Tables

Build it Your Way

Customize your activity tables with custom sizes, color laminates or whiteboard laminate. Shaped tables can be joined together to create flexible workspaces for collaborative learning in large or small groups. Contact Customer Service for custom options.



ACT7245-ALS with white board laminate

Activity Table Overview

Legs: 14-gauge heavy duty steel tube, textured black upper and mounting plate, adjustable chrome leg insert 22.25" to 32.25" height

Attachment: Factory installed stamped plate accepts leg plate, secure leg with supplied screws into pre-drilled holes

Laminate Top: 1.25" high pressure laminate (HPL) with phenolic backer, radius corners

Edgebanding: Radiused Lotz Armor Edge™ or 3mm PVC (beveled Lotz Armor Edge™ is optional)

Finish: Standard or custom laminate

Optional: Chemical resistant laminate available-call Estimating Dept., Junior(-JRALS) legs, adjustable chrome leg insert 17.5" to 23.5" height, beveled Lotz Armor Edge™



Quick mount leg plate assists with quick assembly

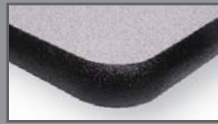

Radius Lotz Armor Edge™



3mm PVC Edge



Non-marring glides



Adjustable legs adjust in 1" increments with tamper resistant screws

HPL Standard Laminate Color Options

WB Kensington Maple*	WB Fusion Maple*	WB Bannister Oak*	WB American Cherry*	WB Wild Cherry*	WB Montana Walnut*	WB Black*	WB Grey Nebula*	WB Dove Grey*
WB Khaki Brown*	WB Almond*	WB White*	WB Hollyberry	WB Woolamai Brush	WB Ocean	WB Tangerine	WB Basket Weaving	WB Eggplant

*Stocked in limited sizes & quantities. Contact Customer Service for lead time.

Complimentary edgeband option for these laminates, matching edgebanding unavailable.



Complete Laminate Collections Available



Stoughton High School, WI

Activity Table

Activity Round Tables



<i>Lotz Armor Edge™</i>	<i>3MM Edge</i>	<i>Top Dia.</i>
ACT7190-ALS	ACT6190-ALS	36"
ACT7191-ALS	ACT6191-ALS	42"
ACT7192-ALS	ACT6192-ALS	48"
ACT7194-ALS	ACT6194-ALS	60"



Trapezoid Activity Tables



<i>Lotz Armor Edge™</i>	<i>3MM Edge</i>	<i>Top DxD</i>
ACT7212-ALS	ACT6212-ALS	24" x 48"
ACT7211-ALS	ACT6211-ALS	30" x 60"



Kidney Activity Tables



<i>Lotz Armor Edge™</i>	<i>3MM Edge</i>	<i>Top DxD</i>
#223 ACT7223-ALS	ACT6223-ALS	36" x 72"
#225 ACT7225-ALS	ACT6225-ALS	36" x 72"
#220 ACT7220-ALS	ACT6220-ALS	48" x 72"
#221 ACT7221-ALS	ACT6221-ALS	48" x 96"



Clover and Flower Activity Tables



<i>Lotz Armor Edge™</i>	<i>3MM Edge</i>	<i>Top Dia.</i>
Clover ACT7250-ALS Clover	ACT6250-ALS	48"
Flower ACT7255-ALS Flower	ACT6255-ALS	60"



Horseshoe Activity and Reader Tables



<i>Lotz Armor Edge™</i>	<i>3MM Edge</i>	<i>Top DxD</i>
#226 ACT7226-ALS	ACT6226-ALS	48" x 72"
#244 ACT7244-ALS (5 legs)	ACT6244-ALS (5 legs)	36" x 72"
#245 ACT7245-ALS	ACT6245-ALS	48" x 72"
#241 ACT7241-ALS (5 legs)	ACT6241-ALS (5 legs)	66" x 60"
#240 ACT7240-ALS (5 legs)	ACT6240-ALS (5 legs)	66" x 60"
#242 ACT7242-ALS (5 legs)	ACT6242-ALS (5 legs)	66" x 60"



Lotz Armor Edge™

Laminate 3MM



Rectangular Activity Tables

<i>Lotz Armor Edge™</i>	<i>3MM Edge</i>	<i>Top DxDL</i>
ACT7065-ALS	ACT6065-ALS	24" x 24"
ACT7066-ALS	ACT6066-ALS	24" x 30"
ACT7067-ALS	ACT6067-ALS	24" x 36"
ACT7068-ALS	ACT6068-ALS	24" x 42"
ACT7069-ALS	ACT6069-ALS	24" x 48"
ACT7070-ALS	ACT6070-ALS	24" x 54"
ACT7071-ALS	ACT6071-ALS	24" x 60"
ACT7072-ALS (stretcher)	ACT6072-ALS (stretcher)	24" x 72"
ACT7073-ALS (6 legs)	ACT6073-ALS (6 legs)	24" x 84"
ACT7078-ALS	ACT6078-ALS	30" x 36"
ACT7079-ALS	ACT6079-ALS	30" x 42"
ACT7080-ALS	ACT6080-ALS	30" x 48"
ACT7082-ALS	ACT6082-ALS	30" x 60"
ACT7083-ALS (stretcher)	ACT6083-ALS (stretcher)	30" x 72"
ACT7084-ALS (6 legs)	ACT6084-ALS (6 legs)	30" x 84"
ACT7085-ALS (6 legs)	ACT6085-ALS (6 legs)	30" x 96"
ACT7088-ALS	ACT6088-ALS	36" x 36"
ACT7089-ALS	ACT6089-ALS	36" x 42"
ACT7090-ALS	ACT6090-ALS	36" x 48"
ACT7092-ALS	ACT6092-ALS	36" x 60"
ACT7093-ALS (stretcher)	ACT6093-ALS (stretcher)	36" x 72"
ACT7094-ALS (6 legs)	ACT6094-ALS (6 legs)	36" x 84"
ACT7095-ALS (6 legs)	ACT6095-ALS (6 legs)	36" x 96"
ACT7098-ALS	ACT6098-ALS	42" x 42"
ACT7120-ALS	ACT6120-ALS	42" x 50"
ACT7099-ALS	ACT6099-ALS	42" x 60"
ACT7100-ALS (stretcher)	ACT6100-ALS (stretcher)	42" x 72"
ACT7107-ALS	ACT6107-ALS	48" x 48"
ACT7108-ALS	ACT6108-ALS	48" x 60"
ACT7109-ALS (stretcher)	ACT6109-ALS (stretcher)	48" x 72"
ACT7111-ALS (6 legs)	ACT6111-ALS (6 legs)	48" x 96"

Lotz Armor Edge™



Laminate 3MM



Stoughton High School, WI

GEO



765-AE



Industry's strongest 35# spring lift support



Upper leg is integrated into the frame of the desk. Features pencil tray and bumpers to eliminate injury to fingers.



GEO Lift Lid Desk

Simple, Functional, Student Desk

With more than 1800 cubic inches of storage, students and teachers will have plenty of room for storing materials without sacrificing classroom space. Fully welded pencil tray on the inside of the book box keeps pencils close at hand. The GEO Lift Lid Desk features a large solid plastic or optional high pressure laminate with Lotz Armor Edge™ work surface. Additionally, the 35# spring lift support hinges open quietly and close gently. Upper leg assembly is welded directly to the steel book box. Adjustable legs with non-marring glides make this desk suitable for students of all sizes and allow for desks to be reconfigured easily in the classroom.

GEO Lift Lid Desk Overview

- Geo Frame: 16-gauge laser cut bookbox with fully welded 14-gauge leg upper, textured black finish
- Leg: 21" chrome leg insert adjustable in 1" increments, non-marring glides
- Plastic Top: 0.625" hard plastic with pencil groove, 35# hinge
- AE Top: 0.75" high pressure laminate (HPL) with beveled Lotz Armor Edge™ and phenolic backer (AE), 35# hinge

HPL Standard Laminate Top Color Options with Lotz Armor Edge™

*Stocked in limited sizes & quantities. Contact Customer Service for lead time.
**Stocked Hard Plastic Colors

Hard Plastic Top Color Options

Complete Laminate Collections Available

GEO Lift Lid Desks

Model #	Description	Top DxDL	Seat Height	Desk Height
765	GEO Lift Lid Desk with Hard Plastic Top	18" x 24"	N/A	23"-33"
765AE	GEO Lift Lid Desk with HPL top and Lotz Armor Edge™	18" x 24"	N/A	23"-33"



Prairie Farm Elementary, WI



TD3000-AC

Teacher's Mobile Desk

Modern Teaching Solutions

Our Teacher's Desk's are designed to be mobile meeting the needs of the modern teacher in a modern classroom. The numerous configurations will help meet the needs of a variety of teachers. Our modesty panels are setback from the edge to accommodate students pulling up to the desk for the teachers help. These fully mobile desks are available with or without a lectern. Backed by a 10-year warranty.



TD1000-AC-UNE



TD3000-AC
(Back View)

teach



TD1000-AC-ELS



TL2040-AC

Teacher's Mobile Lectern

Lecture Here, Lecture There

The fully mobile lectern is available with or without a desk. The adjustable lectern angles up to support a laptop or notes and positions flat to accommodate a document camera or projector. A pencil ledge on the front edge keeps writing instruments and materials in place. Lectern base features secure storage space for supplies and equipment of various sizes.

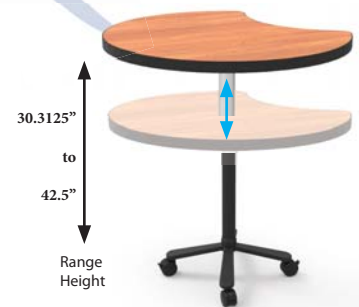

TL1000-AC

30.3125"
to
42.5"
Range
Height

Teacher's Mobile Lecterns

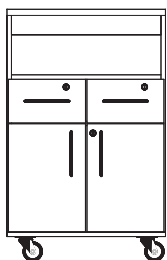

TL2000-AC
26.5"W x 24"D x 41"H

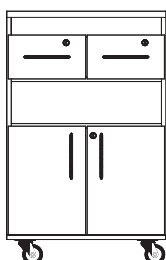

TL2010-AC
26.5"W x 24"D x 41"H

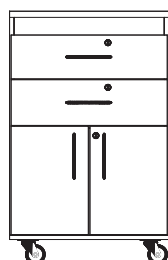

TL2020-AC
26.5"W x 24"D x 41"H

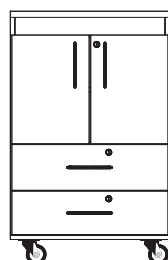

TL2030-AC
26.5"W x 24"D x 41"H

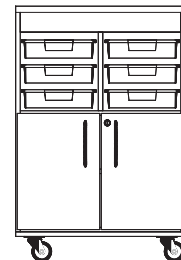

TL2040-AC
28"W x 24"D x 41"H

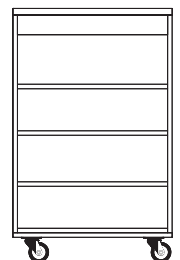

TL2050AC
26.5"W x 24"D x 41"H

Teacher's Mobile Desk and Lectern Overview

- Desk/Lectern Case: Fully doweled 0.75" double-sided thermal fused laminate (TFL) (see page 198 for TFL color options)
- Top: **Desk:** 1.25" high pressure laminate (HPL) worksurface **Lectern:** 1" HPL work surface with adjustable angle hinge and pencil ledge
- Doors: 0.75" TFL with contemporary wire pulls, integrated lock
- Drawers: Fully doweled 0.5" TFL drawer box with 0.75" TFL front, wire pull
- Edge Banding: Matching 0.5mm PVC edge banding, 3mm PVC on doors, drawer fronts and top
- Legs: 15-gauge 1.25" square steel tube with 10-gauge mounting plate, smooth silver finish
- Hinges: 120° hinge
- Shelf: .75" TFL, adjustable with 4 double-pin shelf clips
- Optional: Optional magnets to connect Teacher's Desk with Lectern (left or right side connections), optional key locks for Teacher's Desk



HPL Standard Laminate Color Options

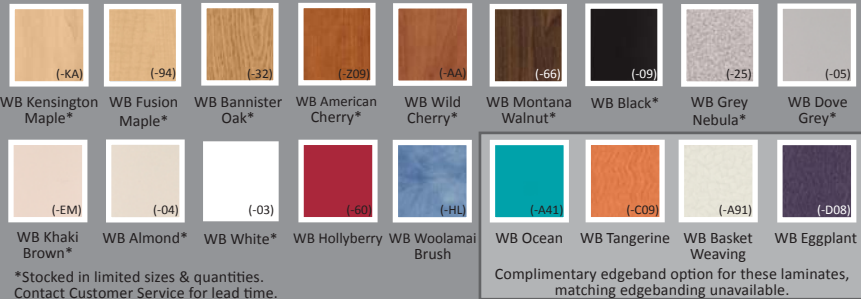

Frame Color Options



Appleton Teacher's Desk

60"W x 24"D x 30"H

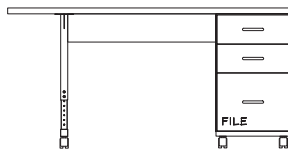

TD1000-AC-UNE

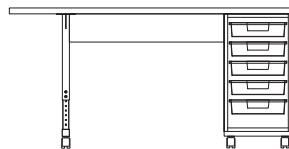

TD1010-AC-UNE

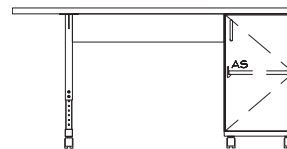

TD1020-AC-UNE

Leg Options

(Optional ELO® legs for Teacher's Desk)

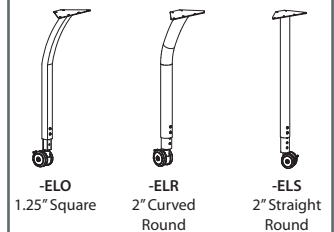

Jackson Teacher's Desk Without Pencil Tray

60"W x 24"D x 30"H

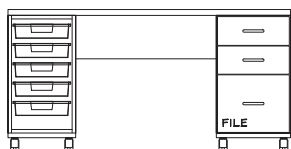

TD2000-AC

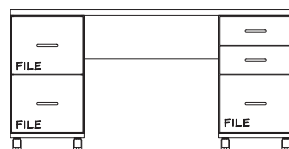

TD2010-AC

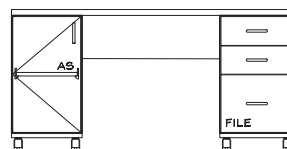

TD2020-AC

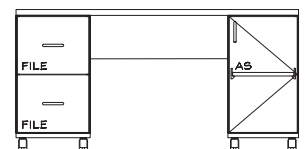

TD2030-AC

Jackson Teacher's Desk With Pencil Tray

60"W x 24"D x 30"H

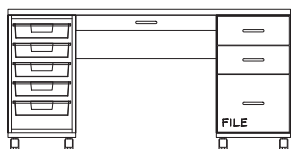

TD3000-AC

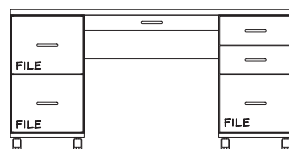

TD3010-AC

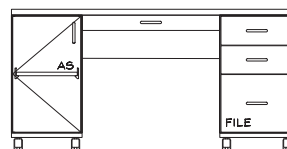

TD3020-AC

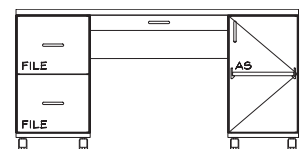

TD3030-AC



SC8021

Mobile Lab Workstation

Convenience and Versatility

Easily roll this durable workstation anywhere you need to go. Workstation is offered with chemical resistant high pressure laminate or phenolic work surface. An optional stainless steel sink with a hand pump provides a portable water source for demonstrations and clean up. Cabinet is constructed of fully doweled thermal fused laminate and includes locking sliding doors and two adjustable shelves. Optional features include rods with a vertical crossbar and reversible mirror/markerboard. Backed with a 10-year warranty.



Stainless steel sink kit with vacuum supply (optional)



Poly holding containers fit neatly under sink adjacent to 2 adjustable shelves



12" L hinged wings feature quick lock arm supports

STEM

Mobile Instructor Desk

With Camera and Presentation Board

Support STEM programs by combining modern technology and learning with the new FlexCam2 and Mobile Instructor's Desk. Designed for use with the Ken-A-Vision FlexCam2, the Mobile Instructor's Desk allows you to take your work anywhere you need to go. The FlexCam2 offers high definition video with USB connectivity. The cabinet is constructed of fully doweled thermal fused laminate with a pull out writing shelf over one file drawer and two standard drawers. Backed with a 10-year warranty.



FlexCam2 high definition camera from Ken-A-Vision



SC8051

Mobile Lab Workstation and Instructor Desk Overview

- Case: Fully doweled 0.75" double-sided thermal fused laminate (TFL) with 0.75" subtop
- Top: 1.25" black chemical resistant laminate with phenolic backer or 1" phenolic resin
- Drawers: Fully doweled 0.5" white box with 0.75" TFL front, wire pull
- Drawer Glides: Standard 0.75" undermount (file drawers have full extension side mount steel ball bearing glide)
- Doors: 0.75" TFL sliding with recessed pulls or 0.75" TFL with wire pulls (depending on model)
- Hinges: 6-point adjustable concealed hinge
- Shelves: TFL (fixed are fully doweled, adjustable have 4 double-pin shelf clips)
- Finish: Standard TFL or custom laminate
- Edge Banding: Matching 0.5mm PVC edge banding, 3mm PVC on doors, drawer fronts and top
- Casters: Heavy duty casters, 2 locking, 2 non-locking (requires field assembly)



0.75" fully doweled casebody construction



Heavy duty casters



Integrated locks (optional)



Demonstration mirror/whiteboard, uprights and crossbar (optional)



Chemical resistant laminate or phenolic top

TFL Standard Laminate Color Options

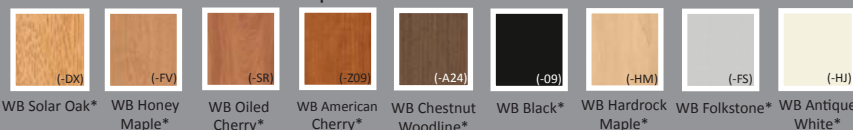

*Stocked in limited sizes & quantities. Contact Customer Service for lead time.



Complete Laminate Collections Available



Mobile Lab Workstation

Model #	Description	Top WxDxH*
SC6001-C	Lab Workstation with Chemical Resistant Laminate (CRL) Top	50" x 27" x 36"
SC6011-C	Lab Workstation with CRL Top and Sink Kit	50" x 27" x 36"
SC6021-C	Lab Workstation with CRL Top, Sink Kit and Upright Cross Bar Mirror/Marker Board Set	50" x 27" x 36"
SC8001	Lab Workstation with Phenolic Top	50" x 27" x 36"
SC8011	Lab Workstation with Phenolic Top and Sink Kit	50" x 27" x 36"
SC8021	Lab Workstation with Phenolic Top, Sink Kit and Upright Cross Bar Mirror/Marker Board Set	50" x 27" x 36"

*With extension wings down

Mobile Instructor Desk

Model #	Description	WxDxH
SC6031-C	Instructor Desk w/Chemical Resistant Laminate (CRL) Top and Ken-A-Vision Camera	48" x 28" x 36"
SC6041-C	Instructor Desk w/CRL Top, Upright and Crossbar and Ken-A-Vision Camera	48" x 28" x 36"
SC6051-C	Instructor Desk w/CRL Top, Mirror/Marker Board Upright Set and Ken-A-Vision Camera	48" x 28" x 36"
SC8031	Instructor Desk w/Phenolic Top and Ken-A-Vision Camera	48" x 28" x 36"
SC8041	Instructor Desk w/Phenolic Top, Upright and Crossbar and Ken-A-Vision Camera	48" x 28" x 36"
SC8051	Instructor Desk w/Phenolic Top, Mirror/Marker Board Upright Set and Ken-A-Vision Camera	48" x 28" x 36"



In-Line Nesting

GIB6071-3030-CH7722

Flip Top Table

Flexible & Convenient

These flip top tables have the flexibility to be used as a table, or when not in use, flipped up and nested out of the way. Locking casters makes it easy to move them around the room. These tables are convenient for meeting or training rooms. Create a unique work area with our variety of shapes.

flip top

Flip Top Table Overview

- Fixed Legs: 14-gauge 2" round steel tube, 27.75" height*
 - Adj Legs: 14-gauge 2" round steel tube, 24.75" to 33.75" height in 1" increments
 - Laminate Top: 1.25" high pressure laminate (HPL) with phenolic backer, radius or square corners, 3mm PVC edge banding or radius Lotz Armor Edge™
 - Flip Mechanism: Injection molded, aluminium and steel, 1 handle release for each pair of legs
- *Contact Estimating Dept. for additional styles and custom heights.



Adjustable Spring Clip



Dual Wheel Locking Casters**
(Standard)



Handle Release
(Half Round, Trapezoid,
Rectangle Tables)



Flip Release
(Round Tables Only)



Gibraltar Tubular X Base



Gibraltar Tubular T Base

HPL Standard Laminate Color Options



WB Kensington Maple* WB Fusion Maple* WB Bannister Oak* WB American Cherry* WB Wild Cherry* WB Montana Walnut* WB Black* WB Grey Nebula* WB Dove Grey*



WB Khaki Brown* WB Almond* WB White* WB Hollyberry WB Woolamai Brush

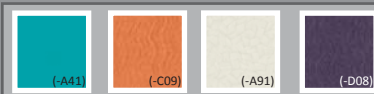

WB Ocean WB Tangerine WB Basket Weaving WB Eggplant
Complimentary edgeband option for these laminates, matching edgebanding unavailable.

Frame Color Options



Black Silver



Complete Laminate Collections Available

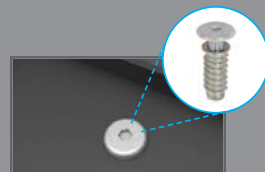

Legs plates attached via threaded metal inserts and screws

*Stocked in limited sizes & quantities. Contact Customer Service for lead time.

**Casters are NOT to be used as leveling devices and requires field assembly.

Flip Top Tables - Fixed Height

<i>Laminate w/Lotz AE™</i>	<i>Laminate w/3mm</i>	<i>Description</i>	<i>Top DxL</i>	<i>Desk H</i>
GIB7069-CH7722	GIB6069-CH7722	Flip Top Table	24" x 48"	29"
GIB7071-CH7722	GIB6071-CH7722	Flip Top Table	24" x 60"	29"
GIB7072-CH7722	GIB6072-CH7722	Flip Top Table	24" x 72"	29"
GIB7080-CH7722	GIB6080-CH7722	Flip Top Table	30" x 48"	29"
GIB7082-CH7722	GIB6082-CH7722	Flip Top Table	30" x 60"	29"
GIB7083-CH7722	GIB6083-CH7722	Flip Top Table	30" x 72"	29"



Inline Nesting Flip Top Tables - Fixed Height

<i>Laminate w/Lotz AE™</i>	<i>Laminate w/3mm</i>	<i>Description</i>	<i>Top DxL</i>	<i>Desk H</i>
GIB7069-3030-CH7722	GIB6069-3030-CH7722	Legs mounted at angle for inline nesting	24" x 48"	29"
GIB7071-3030-CH7722	GIB6071-3030-CH7722	Legs mounted at angle for inline nesting	24" x 60"	29"
GIB7072-3030-CH7722	GIB6072-3030-CH7722	Legs mounted at angle for inline nesting	24" x 72"	29"
GIB7080-3030-CH7722	GIB6080-3030-CH7722	Legs mounted at angle for inline nesting	30" x 48"	29"
GIB7082-3030-CH7722	GIB6082-3030-CH7722	Legs mounted at angle for inline nesting	30" x 60"	29"
GIB7083-3030-CH7722	GIB6083-3030-CH7722	Legs mounted at angle for inline nesting	30" x 72"	29"



Flip Top Tables - Spring Clip Adjustable Height

<i>Laminate w/Lotz AE™</i>	<i>Laminate w/3mm</i>	<i>Description</i>	<i>Top DxL</i>	<i>Desk H</i>
GIB7069-AH-CH7722	GIB6069-AH-CH7722	Flip Top Table	24" x 48"	26"-35"
GIB7071-AH-CH7722	GIB6071-AH-CH7722	Flip Top Table	24" x 60"	26"-35"
GIB7072-AH-CH7722	GIB6072-AH-CH7722	Flip Top Table	24" x 72"	26"-35"
GIB7080-AH-CH7722	GIB6080-AH-CH7722	Flip Top Table	30" x 48"	26"-35"
GIB7082-AH-CH7722	GIB6082-AH-CH7722	Flip Top Table	30" x 60"	26"-35"
GIB7083-AH-CH7722	GIB6083-AH-CH7722	Flip Top Table	30" x 72"	26"-35"



Inline Nesting Flip Top Tables - Spring Clip Adjustable Height

<i>Laminate w/Lotz AE™</i>	<i>Laminate w/3mm</i>	<i>Description</i>	<i>Top DxL</i>	<i>Desk H</i>
GIB7069-AH-3030-CH7722	GIB6069-AH-3030-CH7722	Legs mounted at angle for inline nesting	24" x 48"	26"-35"
GIB7071-AH-3030-CH7722	GIB6071-AH-3030-CH7722	Legs mounted at angle for inline nesting	24" x 60"	26"-35"
GIB7072-AH-3030-CH7722	GIB6072-AH-3030-CH7722	Legs mounted at angle for inline nesting	24" x 72"	26"-35"
GIB7080-AH-3030-CH7722	GIB6080-AH-3030-CH7722	Legs mounted at angle for inline nesting	30" x 48"	26"-35"
GIB7082-AH-3030-CH7722	GIB6082-AH-3030-CH7722	Legs mounted at angle for inline nesting	30" x 60"	26"-35"
GIB7083-AH-3030-CH7722	GIB6083-AH-3030-CH7722	Legs mounted at angle for inline nesting	30" x 72"	26"-35"



Round Flip Top Table

<i>Laminate w/Lotz AE™</i>	<i>Laminate w/3mm</i>	<i>Description</i>	<i>Top DxL</i>	<i>Desk H</i>
GIB7190-CH7526	GIB6190-CH7526	36" Round Fixed Height Table	36"	29"



Half Round Flip Top Table

<i>Laminate w/Lotz AE™</i>	<i>Laminate w/3mm</i>	<i>Description</i>	<i>Top DxL</i>	<i>Desk H</i>
GIB7203-3030-CH7722	GIB6203-3030-CH7722	48" Half Round Fixed Height Table	24" x 48"	29"
GIB7203-AH-3030-CH7722	GIB6203-AH-3030-CH7722	48" Half Round Adjustable Height Table	24" x 48"	26"-35"



Trapezoid Flip Top Table

<i>Laminate w/Lotz AE™</i>	<i>Laminate w/3mm</i>	<i>Description</i>	<i>Top DxL</i>	<i>Desk H</i>
GIB7210-3030-CH7722	GIB6210-3030-CH7722	48" Trapezoid Fixed Height Table	24" x 48"	29"
GIB7210-AH-3030-CH7722	GIB6210-AH-3030-CH7722	48" Trapezoid Adjustable Height Table	24" x 48"	26"-35"





MMTT1000 shown with optional monitor mount and colored top.

Multimedia Team Table

It's All About Group Work

Multimedia tables are becoming more commonplace as collaboration and technology continue to be a constant in schools, libraries and the workplace. Use our multimedia team table with DropShare technology to enhance group learning. Team members working together can share multiple devices on one screen, or students can embrace long-distance learning. With integrated technology connectivity, these tables provide critical tools that make information sharing and group work easier than ever.

share

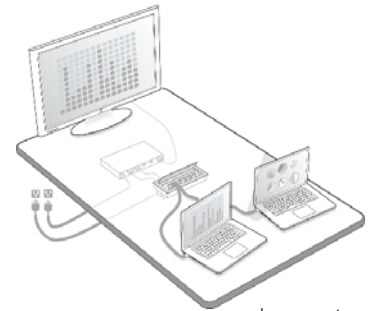

Image courtesy of Byrne.

DropShare

A Media Sharing Solution

Now students and co-workers can share their ideas on a single screen with DropShare, a media sharing solution. Really get the ideas flowing by allowing up to six users to plug in devices like iPads, Surfaces or laptops to share team information quickly. Combined with the E2X Power/Data Center, DropShare can be fitted into just about any WB Manufacturing table or workstation. For more information contact our Customer Service Team at 800.242.2303.

(DropShare is an option on WB Manufacturing Multimedia Team Tables.)



MMTT1000D with optional monitor mount and DropShare (monitor not included).

Monitors and devices not included.

Multimedia Team Table Overview

Body:	1.25" double-sided high pressure laminate (HPL)
Work Surf:	1.25" HPL with phenolic backer, 33"H
Finish:	Standard or custom laminate
Edge Banding:	Matching and/or complimentary edging based on availability of known selection
Base:	Adjustable non-marring glides
Power:	Optional DropShare and E2X media sharing solutions or interchangeable modules for power and media
Optional:	Standard table mount stand for MMTT1000 & MMTT3000, mobile floor stand with tilt mount for MMTT3000, tilt wall mount for MMTT1000D



HPL construction with 3mm edge



DropShare media solutions (optional)



Team tables ship knocked down with joint connectors for easy assembly



Laminate cord channel and removable back (deluxe model)



Deluxe model monitor tilt mount supports 32"-70" monitors (optional)

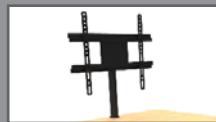

Standard table mount stand supports most 32"-52" monitors (optional)

HPL Standard Laminate Color Options

(-KA)	(-94)	(-32)	(-209)	(-AA)	(-66)	(-09)	(-25)	(-05)
(-EM)	(-04)	(-03)	(-60)	(-HL)	(-A41)	(-C09)	(-A91)	(-D08)

WB Kensington Maple* WB Fusion Maple* WB Bannister Oak* WB American Cherry* WB Wild Cherry* WB Montana Walnut* WB Black* WB Grey Nebula* WB Dove Grey*

WB Khaki Brown* WB Almond* WB White* WB Hollyberry WB Woolamai Brush WB Ocean WB Tangerine WB Basket Weaving WB Eggplant

*Stocked in limited sizes & quantities. Contact Customer Service for lead time.

Complimentary edgeband option for these laminates, matching edgebanding unavailable.



Complete Laminate Collections Available



Multimedia Team Tables

Model #	Description	Wall HxWxD	Table DxD
MMTT1000	Standard Team Table	N/A	42" x 84"
MMTT1000D	Deluxe Team Table with Monitor Wall	72" x 48" x 6.5"	48" x 84"
MMTT3000	Contemporary Team Table	N/A	42" X 84"

Call for monitor mount information. Monitor and monitor mounts not included.

Contemporary Team Table

Let's start Collaborating

Pair our Multimedia Team table with a table mount stand or choose a mobile floor stand. The mobility of the floor stand lets you move from table to table or share between classrooms



Mobile floor stand option.

Large 84" long tables accommodate groups up to six comfortably.



Conference Table

Form Meets Function

WB offers smartly designed conference tables with a choice of tops in traditional shapes or custom tables to meet your specific needs. Combine a custom shape top, base style and color of your choice for a complete custom look for any setting. All tables feature high pressure scratch and stain resistant laminate tops with impact resistant 3mm PVC edges. 30" fixed height tables with leveling glides, standard adjustable leg options and casters are available with custom legs.

confab

Custom Conference Table

Customized Meeting Space

Create diverse conference room environments that integrate technology and offer flexible, functional solutions with versatile tables and coordinating components from WB Manufacturing and Gibraltar. Contact our Customer Service Team for more information.



Choose a Standard Shape or Design Your Own



Race Track

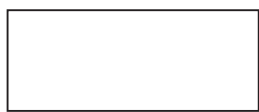

Rectangle

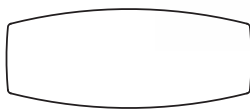

Boat

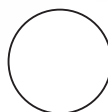

Round

Gibraltar Leg Options



Gibraltar part # 7526
Tubular X Base



Gibraltar part # 5088
DuraCast T Base



Gibraltar part # 5122
DuraCast C Base



Gibraltar part # 7036
Tubular TT Base



Gibraltar part # 7236
Arch TT Base



Gibraltar part # 1143
Panel Base

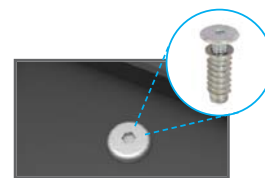

Gibraltar legs plates attached via threaded metal inserts and screws

Conference Table Overview

- Body: 1.25" double-sided high pressure laminate (HPL) legs and stretcher
- Work Surf: 1.25" HPL with phenolic backer, 30"H
- Finish: Standard or custom laminate
- Edge Banding: 3mm PVC
- Base: Matching HPL base with adjustable non-marring glides
- Power: Interchangeable modules for power and media, optional grommets

HPL Standard Laminate Color Options

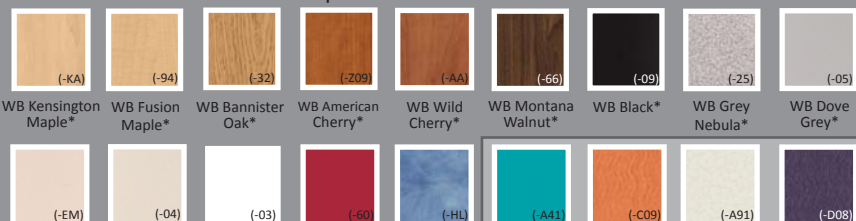

Complete Laminate Collections Available



*Stocked in limited sizes & quantities. Contact Customer Service for lead time.

Complimentary edgeband option for these laminates, matching edgebanding unavailable.

Conference Tables

Top Dxl	36"x72"	36"x96"	36"x120"	36"x144"	48"x72"	48"x96"	48"x120"	48"x144"	57"x72"	57"x96"	57"x120"	57"x144"
Boat	CON6330	CON6331	CON6332	CON6333	CON6334	CON6335	CON6336	CON6337	CON6338	CON6339	CON6340	CON6341
Rce Trk	CON6350	CON6351	CON6352	CON6353	CON6354	CON6355	CON6356	CON6357	CON6358	CON6359	CON6360	CON6361



Athlos Leadership Academy, MN





Workstations

from WB Manufacturing

As technology advances, so does the need for workstations to optimize productivity. WB Manufacturing offers a comprehensive lineup of workstations to accommodate all facets of learning, training, studying and inquiry. From collective learning stations to personal study carrels, training room computer stations to registration kiosks, WB Manufacturing has a workstation for you. Our workstations are fully finished on all sides so they can be placed anywhere in your space.





SCR6079 & SCR6079-AD

Study Carrel

For Classrooms, Libraries and Computer Labs
WB's Study Carrels: The ideal choice for distraction-free test taking and independent study. Tall 47" high end panels that extend 19" above the work surface ensure privacy. Panels are constructed with 1" laminate for lasting durability. The spacious 34"W x 24"D work surface is large enough to accommodate a flat screen monitor or a laptop, in addition to providing a personal work area. A desktop grommet and cord channel make wire management easy. An optional retractable keyboard shelf is also available. Backed by a 10-year warranty.

study

Information Kiosk

Personal Workstations

From foyers to libraries, hiring centers to student enrollment stations, filling out an application or checking a registry, WB Manufacturing's Information Kiosk provides a convenient station for self service solutions. Generous 34"W x 24"D work area can easily accommodate a flat screen monitor and keyboard or a laptop. Kiosks can also be used as stand-up workstations for educators, employees and students who prefer to be on their feet as they work. A desktop grommet and cord channel make wire management easy. Optional retractable keyboard tray available.



CK6079

Study Carrel and Information Kiosk Overview

- Panels: 1" double-sided high pressure laminate (HPL)
- Surface: 1.25" HPL with phenolic backer, 34"W x 24"D
- Finish: Standard or custom laminate
- Edge Banding: Matching and/or complimentary edging based on availability of known selection
- Base: Adjustable non-marring nylon glides
- Options: Pull out keyboard tray



Contemporary design, HPL construction



Side and back panels join via metal slip joints



Work surface provides ample room for monitor



Nylon glides protect floors



Pull out keyboard tray (optional)

HPL Standard Laminate Color Options

(-KA)	(-94)	(-32)	(-209)	(-AA)	(-66)	(-09)	(-25)	(-05)
WB Khaki Brown* (-EM)	WB Almond* (-04)	WB White* (-03)	WB Hollyberry (-60)	WB Woolamai Brush (-HL)	WB Ocean (-A41)	WB Tangerine (-C09)	WB Basket Weaving (-A91)	WB Eggplant (-D08)

*Stocked in limited sizes & quantities. Contact Customer Service for lead time.

Complimentary edgeband option for these laminates, matching edgebanding unavailable.



Complete Laminate Collections Available

Study Carrels and Information Kiosks

Model #	Description	WxDxL
SCR6079	Study Carrel with 3mm Edge, Work Surface 28"H	36" x 33" x 47"
SCR6079-AD	Study Carrel Adder Unit with 3mm Edge, Work Surface 28"H	36" x 33" x 47"
CK6079	Information Kiosk with 3mm Edge, Work Surface 41"H	36" x 33" x 47"
CK6079-AD	Information Kiosk Adder Unit with 3mm Edge, Work Surface 41"H	36" x 33" x 47"

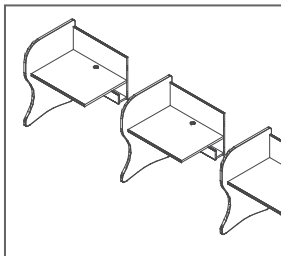

Adder units (-AD) create semi-custom units or can be used when adding onto existing units.



Perfect for training or testing centers.







Collaborative Workstations

from WB Manufacturing

Collaborative Workstations will make your STEM Classroom complete. These smartly designed and modern collaborative workstations enable students the ability to work together on problem solving and project-based activities. Better yet, every workstation that WB has designed will increase communication and collaboration between students because there is always a visual connection between each other.



CLW7252-C-AC

Collaborative Workstation

Create 21st Century Learning Environments

These collaborative workstations enable students to work together on problem solving and project-based activities. The 48" diameter work surface comfortably seats up to four students, who can easily access stored supplies from all sides of the cabinet base by two, 24" diameter turn-style shelves. Optional doors with chrome pull handles and locks on the base keep supplies secure, and 5-knuckle hinges allow for a 270° opening so doors lay flat against base and will not interfere with leg room when workstation is in use. Workstation base is constructed of fully doweled 3/4" thermal fused laminate with finished toe kick and glides including levelers adjustable from the inside of the cabinet. Other options are available (see facing page). Cabinets arrive fully assembled, with the exception of the top, which ships separately. Backed by a 10-year warranty.



CLW8192-DL

collaborate

Tomah & Urban Edge Workstation

Modernize Your STEM Classroom Today!

These NEW collaborative workstations will make your STEM Classroom complete. Collaborative work areas promote face to face interaction which encourages creativity in the classroom.

Easily move these units around the room creating open work areas or move about to easily cleanup messes. Choose from our various heights to accommodate the numerous projects while keeping the room looking uniform. Backed by a 10-year warranty.



CLW7092-AC



CLW7253-AC

Collaborative Workstation Overview

Case:	Fully doweled 0.75" double-sided thermal fused laminate (TFL) with 0.75" subtop
Tops:	1.25" high pressure laminate (HPL) or chemical resistant laminate with radius Lotz Armor Edge™ or 1" phenolic resin
Doors:	0.75" TFL with contemporary pulls
Hinges:	Heavy duty 5-knuckle hinge with 270° swing allows doors to lay flat (Collaborative Workstation), 6-point adjustable concealed hinge (Tomah & Urban Edge)
Shelves:	TFL shelves, fixed, fully doweled
Turn Style:	White polymer 24" diameter
Finish:	Standard TFL or custom laminate
Edge Banding:	Matching 0.5mm PVC edge banding, 3mm PVC on doors
Base:	Integrated, fully finished base with built in levelers adjustable from inside cabinet
Casters:	3" heavy duty casters on -AC models, 2 locking, 2 non-locking (Casters are NOT to be used as leveling devices and requires field assembly.)



1.25" CRL top with Lotz Armor Edge™



1" phenolic resin top



White 24" Lazy Susan/ Turn Table



Integrated locks (optional)



Built-in levelers



Heavy duty casters on -AC models

TFL Standard Laminate Color Options

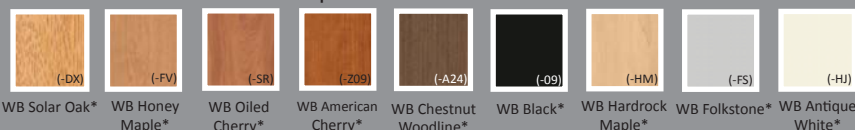

WB Solar Oak* (-DX) WB Honey Maple* (-FV) WB Oiled Cherry* (-SR) WB American Cherry* (-Z09) WB Chestnut Woodline* (-A24) WB Black* (-09) WB Hardrock Maple* (-HM) WB Folkstone* (-FS) WB Antique White* (-HJ)



Complete Laminate Collections Available



5-knuckle hinge (Collaborative Workstation)



6-point adjustable hinge (Tomah & Urban Edge)

*Stocked in limited sizes & quantities. Contact Customer Service for lead time.

Collaborative Workstations

Model #	Description	Case WxDxH
CLW8192	48" Round Phenolic Top, Open with Shelves	27.25" x 27.25" x 31"
CLW8192-L	48" Round Phenolic Top, Open with 24" Lazy Susan Turn Table	27.25" x 27.25" x 31"
CLW8192-DL	48" Round Phenolic Top, 4 Doors with 24" Lazy Susan Turn Table	27.25" x 27.25" x 31"
CLW7192	48" Round HPL Laminate AE™ Top, Open with Shelves	27.25" x 27.25" x 31"
CLW7192-L	48" Round HPL Laminate AE™ Top, Open with 24" Lazy Susan Turn Table	27.25" x 27.25" x 31"
CLW7192-DL	48" Round HPL Laminate AE™ Top, 4 Doors with 24" Lazy Susan Turn Table	27.25" x 27.25" x 31"
CLW7192-C	48" Round CRL Laminate AE™ Top, Open with Shelves	27.25" x 27.25" x 31"
CLW7192-C-L	48" Round CRL Laminate AE™ Top, Open with 24" Lazy Susan Turn Table	27.25" x 27.25" x 31"
CLW7192-C-DL	48" Round CRL Laminate AE™ Top, 4 Doors with 24" Lazy Susan Turn Table	27.25" x 27.25" x 31"

Mobile Collaborative Workstations

CLW7092-AC	Tomah 60"x36" Laminate AE™ Top, 2 Doors, 2 Open, Adj. Shelves & Casters	48" x 48" x 40"
CLW7092-C-AC	Tomah 60"x36" CRL Laminate AE™ Top, 2 Doors, 2 Open, Adj. Shelves & Casters	48" x 48" x 40"
CLW7252-AC	Urban Edge 48.625" Laminate AE™ Top, 4 Doors, Adj. Shelves and Casters	30" x 30" x 40"
CLW7253-AC	Urban Edge XL 60" Laminate AE™ Top, 2 Doors, 4 Drawers, 2 Open, Adj. Shelves & Casters	36" x 36" x 36"
CLW7252-C-AC	Urban Edge 48.625" CRL Laminate AE™ Top, 4 Doors, Adj. Shelves and Casters	30" x 30" x 40"
CLW7253-C-AC	Urban Edge XL 60" CRL Laminate AE™ Top, 2 Doors, 4 Drawers, 2 Open, Adj. Shelves & Casters	36" x 36" x 36"



storage solutions

Modular and Mobile Storage

from WB Manufacturing

When we say modular and mobile solutions, we mean just that. The Storage Solutions series from WB Manufacturing offers perfect accessory solutions to your fixed casework. Fully finished furniture, the Storage Solution Series can be placed anywhere and moved at anytime. With features like tote, paper, art, book and tech storage, WB Manufacturing has mobile and modular storage solutions to meet all your needs. If one of our standard solutions does not fit your needs, contact our Customer Service Team and let WB Manufacturing design, build and deliver a custom solution. Ten year warranty.



SS5070-AC



SS5020-AC

Transporter Mobile Storage

Portable Solutions

Versatile multi-purpose mobile storage cabinets, totes, file drawers, shelving and wardrobe options allow plenty of space for storing jackets, supplies, personal belongings and more. Mobile storage cabinets are constructed of durable thermal fused laminate throughout with matching PVC edge banding. Additionally, heavy duty, 300 lb. capacity casters make transporting supplies over thresholds, across floors and on rough terrain a cinch. Arrives fully assembled. Ten year warranty.



SS5000-AC

mobile



SS5060-AC
20 Totes

Door shown transparent to see interior.



SS5070-AC
20 Totes

Transporter Mobile Storage Overview

- Case: Fully doweled 0.75" double-sided thermal fused laminate (TFL) with matching top over 0.75" subtop
- Drawers: Fully doweled 0.75" TFL box with 0.75" TFL front, contemporary pull
- Drawer Glides: Standard 0.75" undermount (file drawers have full extension side mount steel ball bearing glide)
- Doors: 0.75" TFL with contemporary pulls and locks
- Hinges: Heavy duty 5-knuckle hinge
- Shelves: TFL (fixed are fully doweled, adjustable have 4 double-pin shelf clips)
- Finish: Standard TFL or custom laminate
- Edge Banding: Matching 0.5mm PVC edge banding, 3mm PVC on doors, drawer fronts and top
- Casters: 5" Heavy duty casters, 2 locking, 2 non-locking: Casters are NOT to be used as leveling devices and requires field assembly.



0.75" matching TFL drawer box with undermount glides



Shelves and double-pin clips



14-gauge steel garment rod



Heavy duty casters



Contemporary pull handles & locks



Vertical wardrobe lock adds extra security

TFL Standard Laminate Color Options



WB Solar Oak*



WB Honey Maple*



WB Oiled Cherry*



WB American Cherry*



WB Chestnut Woodline*



WB Black*



WB Hardrock Maple*



WB Folkstone*



WB Antique White*

*Stocked in limited sizes & quantities. Contact Customer Service for lead time.

Transporter Mobile Storage

Model #	Description	WxDxH
SS5000-AC	1 Fixed and 4 Adj. Shelves, Casters	36", 48" x 24" x 60", 72"
SS5010-AC	Center Divider, 2 Fixed and 8 Adj. Shelves, Casters	48" x 24" x 60", 72"
SS5020-AC	Wardrobe, Garment Rod, Divider, 2 Fixed Shelves and 4 Adj. Shelves, Casters	36", 48" x 24" x 60", 72"
SS5030-AC	Wardrobe, Garment Rod, Divider, 1 Fixed Shelf, 3 Adj. Shelves, 2 File Drawers, 2 Drawers, Casters	48" x 24" x 72"
SS5040-AC	Wardrobe, Garment Rod, Divider, 2 Fixed Shelves, 2 Adj. Shelves, 2 File Drawers, Casters	48" x 24" x 60", 72"
SS5060-AC	Wardrobe, Garment Rod w/Door, 20 Totes w/Divider, 2 Fixed Shelves, 1 Adj. Shelf, Casters	42" x 24" x 72"
SS5070-AC	Wardrobe, Garment Rod, Divider, 20 Totes w/Divier, 2 Fixed Shelves, Casters	42" x 24" x 72"





SS4000

Combination Tall Storage Cabinet

Classroom Organization

The Combination Tall Storage Cabinet with locking doors and drawers is perfect for the classroom, art and science labs, and other school or training facility storage. Four adjustable 1" thick shelves provide strong support and can accommodate an array of storage needs, and locking drawers and doors provide security for valuable supplies. Fully finished on all sides and equipped with hidden levelers adjustable from the inside, this stand alone storage cabinet arrives fully assembled and requires no installation. Ten year warranty.



SS4000

organize

Portfolio & Tote Tray Storage Cabinets

Flat File and Supply Solutions

Store and organize portfolios, canvases and a multitude of paper and supplies with these versatile storage cabinets. Use together or separately depending on your storage needs. Tote Tray Storage Cabinets include 27 Glide and Tilt clear tote trays. The Portfolio Storage Cabinet is designed to sit on top of the Tote Tray Storage Cabinet, or on existing cabinets, and includes 14 power-coated wire dividers for storing up to 16 portfolios or canvases of varying widths up to 24"H. Consider positioning cabinets together as room dividers; the finished furniture-style backs make these cabinets attractive from all sides. Cabinets arrive fully assembled. Ten year warranty.



APMU/APMB



Combination Tall Storage, Portfolio & Tote Tray Storage Overview

Case:	Fully doweled 0.75" double-sided thermal fused laminate (TFL) with matching top over 0.75" subtop
Drawers:	Fully doweled 0.75" TFL box with 0.75" TFL front, contemporary wire pull (SS4000)
Drawer Glides:	Standard heavy duty side mount steel ball bearing glide (SS4000)
Totes:	12.25"W x 16.75"L x 2.75"H clear Glide & Tilt tote trays included (APMB)
Doors:	0.75" TFL with contemporary pulls (SS4000) (optional vertical bar lock)
Hinges:	Heavy duty 5-knuckle hinge (SS4000)
Shelves:	TFL (fixed are fully doweled, adjustable have 4 double-pin shelf clips)
Dividers:	0.25" adjustable/removable powder coated black wire dividers (SS3000s AMPU)
Finish:	Standard TFL or custom laminate
Edge Banding:	Matching 0.5mm PVC edge banding, 3mm PVC on doors, drawer fronts and top
Base:	Integrated, fully finished base with built in levelers adjustable from inside cabinet



Matching TFL top over 0.75" subtop

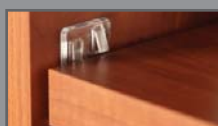

Shelves and double-pin clips



Built-in levelers



Contemporary pulls (SS4000) and locks (optional)



Clear trays organize supplies and can easily be taken to the work area (AMPB)

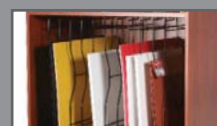

Black wire separators provide sturdy separation (SS3000/AMPU)

TFL Standard Laminate Color Options

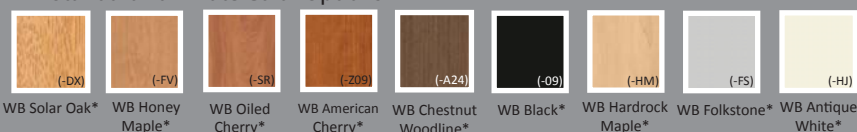

WB Solar Oak* (-DX) WB Honey Maple* (-FV) WB Oiled Cherry* (-SR) WB American Cherry* (-Z09) WB Chestnut Woodline* (-A24) WB Black* (-09) WB Hardrock Maple* (-HM) WB Folkstone* (-FS) WB Antique White* (-HJ)



Complete Laminate Collections Available

*Stocked in limited sizes & quantities. Contact Customer Service for lead time.

Combination Tall Storage Cabinet

Model #	Description	WxDxH
SS4000	Tall storage, 4 Adjustable Shelves, 2 Doors, 4 Drawers	48" x 24" x 84"

Portfolio Storage Cabinet

Model #	Description	WxDxH
SS3000	Portfolio Storage, 3 Shelves, 36 Adjustable Black Wire Dividers	36" x 31" x 84"

Portfolio & Tote Tray Storage Cabinet

Model #	Description	WxDxH
APMU	Portfolio Manager - Upper Unit, 14 Adjustable Black Wire Dividers	42" x 24" x 27"
APMB	Portfolio Manager - Lower Unit with 27 Trays	42" x 24" x 40"



Glide & Tilt storage tote trays are perfect for any organizational task. Trays are removable for portability and integrate easily with many of our desks.



SS3000



SS2065
18-Tote Storage

Tote Storage Unit

Mobile and Modular Solutions

Tote Storage Units are perfect for organizing and storing supplies for any classroom, office or training center. Glide & Tilt trays are removable and compatible with many of our desks and keep students and supplies organized. Our fully doweled thermal fused laminate construction allows all of WB Manufacturing's tote storage to stand up to the rigors of daily use. Ten year warranty.



SS2075-AC
13-Tote Front
13-Tote Back

totes



Glide & Tilt storage tote trays are perfect for any organizational task. Trays are removable for portability and integrate easily with many of our desks.



SS2050-AC
15-Tote Storage
Shown with optional colored top.



SS2040-AC
10-Tote Storage
Shown with optional colored top.



SS2020
30-Tote Storage

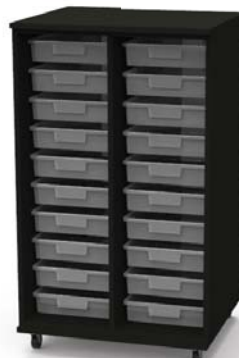

SS2010-AC
20-Tote Storage



SS2035-AC
48-Tote Storage

Tote Storage Unit Overview

- Case: Fully doweled 0.75" double-sided thermal fused laminate (TFL) with matching top over 0.75" subtop
- Totes: 12.25"W x 16.75"L x 2.75"H clear Glide & Tilt tote trays included (can be interchanged with totes on desks)
- Doors: 0.75" TFL with contemporary pulls (optional locks)
- Hinges: Heavy duty 5-knuckle hinge
- Finish: Standard TFL or custom laminate
- Edge Banding: Matching 0.5mm PVC edge banding, 3mm PVC on doors, drawer fronts and top
- Base: Integrated, fully finished base with built in levelers adjustable from inside cabinet
- Casters: Heavy duty casters, 2 locking, 2 non-locking (3" or 5" depending on model) (-AC) (Casters are NOT to be used as leveling devices and requires field assembly.)



Matching TFL top over 0.75" subtop (standard)



Glide & Tilt tote trays (can be interchanged with totes on desks)



Heavy duty 5-knuckle, 270° hinge allows door to lay flat



Heavy duty casters included on models with -AC



Built-in levelers



Optional 6" totes and tray inserts available

TFL Standard Laminate Color Options



WB Solar Oak* (-DX)



WB Honey Maple* (-FV)



WB Oiled Cherry* (-SR)



WB American Cherry* (-Z09)



WB Chestnut Woodline* (-A24)



WB Black* (-09)



WB Hardrock Maple* (-HM)



WB Folkstone* (-FS)



WB Antique White* (-HJ)



Complete Laminate Collections Available



Optional laminate top

*Stocked in limited sizes & quantities. Contact Customer Service for lead time.

10 Tote Storage

Model #	Description	WxDxH
SS2040	Open, 1 Adj. Shelf, Levelers	42" x 23" x 28"
SS2040-AC	Open, 1 Adj. Shelf, Casters	42" x 23" x 30"
SS2045	With Doors, 1 Adj. Shelf, Levelers	42" x 23" x 28"
SS2045-AC	With Doors, 1 Adj. Shelf, Casters	42" x 23" x 30"

26 Tote Storage

Model #	Description	WxDxH
SS2070	2-Sided Open, 6 Adj. Shlv., Levelers	34" x 42" x 58"
SS2070-AC	2-Sided Open, 6 Adj. Shlv., Casters	34" x 42" x 60"
SS2075	2-Sided w/Dr., 6 Adj. Shlv., Levelers	34" x 42" x 58"
SS2075-AC	2-Sided w/Dr., 6 Adj. Shlv., Casters	34" x 42" x 60"

15 Tote Storage

Model #	Description	WxDxH
SS2050	Open, Levelers	42" x 23" x 28"
SS2050-AC	Open, Casters	42" x 23" x 30"
SS2055	With Doors, Levelers	42" x 23" x 28"
SS2055-AC	With Doors, Casters	42" x 23" x 30"

30 Tote Storage

Model #	Description	WxDxH
SS2020	Open, Levelers	42" x 24" x 46"
SS2020-AC	Open, Casters	42" x 24" x 48"
SS2025	With Doors, Levelers	42" x 24" x 46"
SS2025-AC	With Doors, Casters	42" x 24" x 48"

18 Tote Storage

Model #	Description	WxDxH
SS2060	Open, 2 Adj. Shelves, Levelers	42" x 24" x 68"
SS2060-AC	Open, 2 Adj. Shelves, Casters	42" x 24" x 72"
SS2065	With Doors, 2 Adj. Shelves, Levelers	42" x 24" x 68"
SS2065-AC	With Doors, 2 Adj. Shelves, Casters	42" x 24" x 72"

48 Tote Storage

Model #	Description	WxDxH
SS2030	Open, Levelers	42" x 24" x 68"
SS2030-AC	Open, Casters	42" x 24" x 72"
SS2035	With Doors, Levelers	42" x 24" x 68"
SS2035-AC	With Doors, Casters	42" x 24" x 72"

20 Tote Storage

Model #	Description	WxDxH
SS2010	Open, Levelers	28" x 24" x 46"
SS2010-AC	Open, Casters	28" x 24" x 48"
SS2015	With Door, Levelers	28" x 24" x 46"
SS2015-AC	With Door, Casters	28" x 24" x 48"



Flat Storage

Flat File and Large Document

Store and protect your large files, graphics and blueprints from wrinkles and damage. Whether it be posters or blue prints, artwork or large format photos, WB Manufacturing can provide safe, organized storage for all your flat file needs. With our standard casebody construction of fully doweled thermal fused laminate and choice of units with adjustable shelves, roll-out shelves, locking doors and drawers, casters or levelers, we are certain we have you covered. Cabinets arrive fully assembled. Made in the USA. Backed with a 10-year warranty.

paper



Cabinets Are Available with and without Casters.

SS1000-AC

Flat Storage Overview

- Case: Fully doweled 0.75" double-sided thermal fused laminate (TFL) with matching top over 0.75" subtop
- Drawers: Fully doweled 0.75" TFL box with 0.75" TFL front, contemporary wire pull
- Drawer Glides: Standard heavy duty side mount full extension, steel ball bearing glides
- Doors: 0.75" TFL with contemporary pulls
- Hinges: Heavy duty 5-knuckle hinge with 270° swing allows doors to lay flat
- Shelves: TFL (fixed are fully doweled, adjustable have 4 double-pin shelf clips)
- Finish: Standard TFL or custom laminate
- Edge Banding: Matching 3mm PVC edge banding on doors, drawer fronts and top
- Base: Integrated, fully finished base with built in levelers adjustable from inside cabinet
- Casters: 3" Heavy duty casters, 2 locking, 2 non-locking (-AC) (Casters are NOT to be used as leveling devices and requires field assembly.)



Matching TFL top over 0.75" subtop



Heavy duty drawer glides



Contemporary pulls and (optional) locks



Heavy duty casters included on models with -AC



Built-in levelers



Shelves and double-pin clips

TFL Standard Laminate Color Options

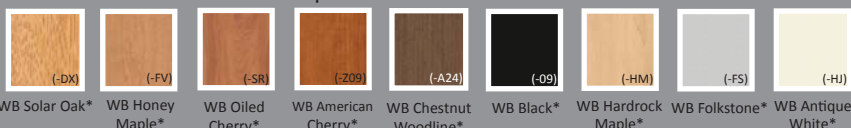

Complete Laminate Collections Available

*Stocked in limited sizes & quantities. Contact Customer Service for lead time.

Adjustable Shelf Flat Storage

Model #	Description	WxDxH
SS1000	Flat Storage, 4 Adjustable Shelves, w/o Doors, Levelers	48" x 30" x 36"
SS1000-AC	Flat Storage, 4 Adjustable Shelves, w/o Doors, Casters	48" x 30" x 36"

5 Drawer Flat Storage

Model #	Description	WxDxH
SS1010	Flat Storage, 5 Drawers, Levelers	48" x 30" x 36"
SS1010-AC	Flat Storage, 5 Drawers, Casters	48" x 30" x 36"

Roll Out Flat Storage

Model #	Description	WxDxH
SS1020	Flat Storage, 6 Roll-out Shelves, w/o Doors, Levelers	48" x 30" x 36"
SS1020-AC	Flat Storage, 6 Roll-out Shelves, w/o Doors, Casters	48" x 30" x 36"
SS1025	Flat Storage, 6 Roll-out Shelves, w/Doors, Levelers	48" x 30" x 36"
SS1025-AC	Flat Storage, 6 Roll-out Shelves, w/Doors, Casters	48" x 30" x 36"



SS1020-AC

Fully Finished Sides and Back





SSTC1005-AC

Tablet Storage Cabinet

We're Plugged In...Are You?

The ultimate convenience for computer labs, classrooms, or offices, these 24 and 48 device iPad/Tablet Storage Cabinets offer front and rear locking doors that open a full 270° and lay flat against the cabinet for easy access of devices. Plus, 1" thick laminate shelves equipped with 20 or 40 powder coated 1/4" removable wire dividers secure up to 24 or 48 devices. Grommets and ventilated rear door provide proper air flow to protect equipment from overheating.

techno

Additionally, power for charging is provided by a 24 outlet power strip (two power strips provided for 48 device cabinets) with a 6' cord. Chrome hooks are furnished for storage of cord inside cabinet and out of sight when not in use. Cabinets arrive fully assembled. Backed with a 10-year warranty.

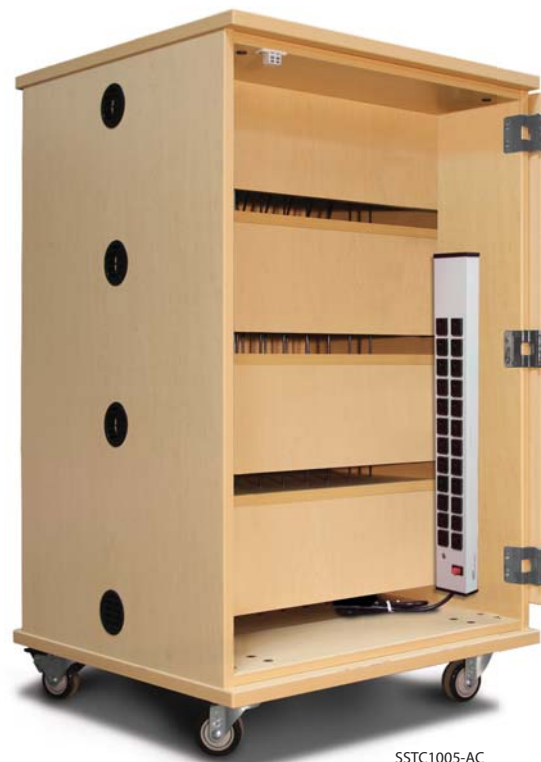

SSTC1005-AC

Rear door design provides additional ventilation and secured charging of devices.

Tech Storage Cabinet Overview

- Case: Fully doweled 0.75" double-sided thermal fused laminate (TFL) with matching top over 0.75" subtop, louvered grommets for circulation
- Dividers: 0.25" diameter adjustable/removable black wire dividers
- Doors: 0.75" TFL with contemporary pulls, recessed pull on back door, and integrated lock
- Hinges: Heavy duty 5-knuckle hinge with 270° swing allow doors to lay flat
- Shelves: TFL (fixed are fully doweled, adjustable have 4 double-pin shelf clips), nylon clips keep cords from falling behind shelves
- Finish: Standard TFL or custom laminate
- Edge Banding: Matching 0.5mm PVC edge banding, 3mm PVC on doors, drawer fronts and top
- Base: Integrated, fully finished base with built in levelers adjustable from inside cabinet
- Casters: 3" heavy duty casters, 2 locking, 2 non-locking (Casters are NOT to be used as leveling devices and requires field assembly.)
- Power: UL approved outlet power strip with 6' cord



Matching TFL top over 0.75" subtop



Contemporary pulls and integrated lock



0.25" adjustable black wire dividers



Heavy duty casters

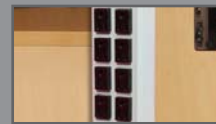

24 outlet power strips provide for minimal cords to wall



Shelves and double-pin clips

TFL Standard Laminate Color Options

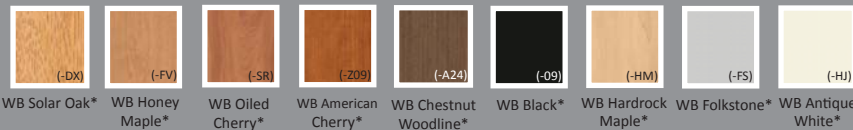

Complete Laminate Collections Available

*Stocked in limited sizes & quantities. Contact Customer Service for lead time.

Tech Storage Cabinets

Model #	Description	WxDxH
SSTC1105	24 Tablet Cabinet w/Doors, Levelers	27.625" x 25" x 43.5"
SSTC1105-AC	24 Tablet Cabinet w/Doors, Casters	27.625" x 25" x 45.75"
SSTC1005	48 Tablet Cabinet w/Doors, Levelers	27.625" x 25" x 43.5"
SSTC1005-AC	48 Tablet Cabinet w/Doors, Casters	27.625" x 25" x 45.75"
SSTC2000-AC	28 Charging Cart, Fixed Shelves, Access Door, Casters	32.625" x 32.625" x 43.125"



This slick Charging Cart was designed to hold 28 chromebooks but it is also universal to be used for tablets and other laptop devices.

3D Printer Station

STEM ready....

As STEM and STEAM Labs flow into all grade levels, use this mobile cabinet to store your tools and materials needed for your 3D Printer. Safely store electronics and other valuables, with the comfort of locking doors and drawers. The oversized countertop makes it convenient to place your 3D Printer along with a programming laptop on the top surface and work at it. Easily share your 3D Printer, along with all of its necessities, between classrooms with the casters option, or reposition in your classroom with the Replay base.



3D



3D Printer Station Overview

- Case: Fully doweled 0.75" double-sided thermal fused laminate (TFL) with matching top over 0.75" subtop
- Countertops: 1" high pressure laminate(HPL) top over 0.75"TFL subtop
- Doors: 0.75"TFL with contemporary pulls
- Hinges: 6-point adjustable concealed hinge
- Shelves: TFL (fixed are fully doweled, adjustable have 4 double-pin shelf clips)
- Finish: Standard TFL on cases, standard or custom HPL on countertops
- Edge Banding: Matching 0.5mm PVC edge banding, 3mm PVC on doors, drawer fronts and countertop
- Casters: 3" heavy duty casters, 2 locking, 2 non-locking (Casters are NOT to be used as leveling devices and requires field assembly.)



1" HPL top with 1.125" overhang over a 0.75" subtop



Contemporary pulls



0.75" fully doweled TFL casebody construction



Heavy duty casters



6-point adjustable hinge (standard)



Shelves and double-pin clips

TFL Standard Laminate Color Options



(-DX)

WB Solar Oak*



(-FV)

WB Honey Maple*



(-SR)

WB Oiled Cherry*



(-Z09)

WB American Cherry*



(-A24)

WB Chestnut Woodline*



(-09)

WB Black*



(-HM)

WB Hardrock Maple*



(-FS)

WB Folkstone*



(-HJ)

WB Antique White*



Complete Laminate Collections Available



3mm PVC door and drawer matching edgebanding

*Stocked in limited sizes & quantities. Contact Customer Service for lead time.

3D Printer Station

Model #	Description	WxDxH
RB2000-AC	2 Drawers, 3 Open Shelves, 1 Adj. Shelf	44.25" x 30" x 34"
RB2001-AC	1 Door, 3 Open Shelves, 4 Adj. Shelves	44.25" x 30" x 34"
RB2002-AC	2 Drawers, 1, Open Shelf, 1 Door, 1 Adj. Shelf	44.25" x 30" x 34"
RB2003-AC	6 Open Shelves, 4 Adj. Shelves	44.25" x 30" x 34"
RB2004-AC	2 Doors, 2 Adj. Shelves	44.25" x 30" x 34"
RB2005-AC	1 Door, 4 Drawers, 1 Adj. Shelf	44.25" x 30" x 34"
RB2006-AC	1 Door, 3 Drawers, 1 Adj. Shelf	44.25" x 30" x 34"
RB2007-AC	6 Drawers	44.25" x 30" x 34"
RB2008-AC	3 Drawers, 2 Open Shelves, 1 Adj. Shelf	44.25" x 30" x 34"
RB2009-AC	2 Drawers, 1 Open Shelf	32.25" x 30" x 34"
RB2010-AC	2 Open Shelves, 1 Adj. Shelf	32.25" x 30" x 34"
RB2011-AC	LH Door, 1 Adj. Shelf	32.25" x 30" x 34"
RB2021-AC	RH Door, 1 Adj. Shelf	32.25" x 30" x 34"
RB2012-AC	LH Door, 1 Drawer	32.25" x 30" x 34"
RB2022-AC	RH Door, 1 Drawer	32.25" x 30" x 34"
RB2013-AC	3 Drawers	32.25" x 30" x 34"
RB2014-AC	1 Drawer, 1 Open Shelf	32.25" x 30" x 34"



RB2001-AC



RB2007-AC



RB2010-AC



RB2011-AC



RB2014-AC





Rhapsody® Modular Music Storage

from WB Manufacturing

Developed using the same construction standards as our popular "REplay" cabinets, Rhapsody Music Storage features stand alone cabinets that install easily and let you arrange, re-arrange and add to your music room as your needs change, or "RE-play" your cabinets into any room, at any time. Completely finished backs and toe kicks and built-in levelers allow cabinets to be installed like furniture, leaving walls and flooring untouched and minimizing labor and remodeling costs. Add additional cabinets in the future or add custom cabinets to get exactly what you need.





Rhapsody® Music Storage

Orchestrated Solutions

WB Manufacturing offers more than 100 standard cabinets, featuring countless compartment options for clarinets to flugelhorns, trombones to timpanies, uniforms to folios. WB Manufacturing, in-tune with all your music storage needs. Cabinets arrive fully assembled.*



*Cabinets that are 48" or 60" wide do not come fully assembled. Racks are not assembled.

music

A Higher Note

Lotz Armor Edge™ Shelves

Our music storage cabinets feature 1" thick medium density fiberboard shelves with a radius front and durable Lotz Armor Edge™ spray-on black polyurea coating on the top and front edge. No warping, peeling or replacement, and shelves are fully doweled into case for maximum strength.

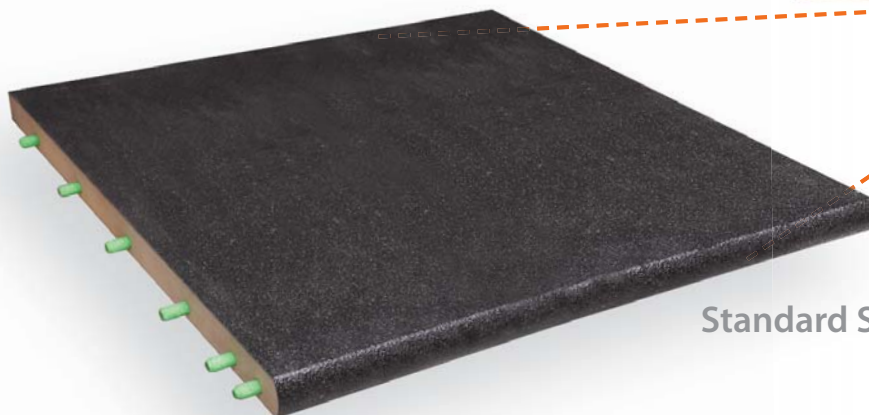

Standard Shelf



Rhapsody® Music Storage Overview

- Case: Fully doweled 0.75" double-sided thermal fused laminate (TFL) with matching top over 0.75" subtop
- Wire Doors: Fully welded steel wire grille doors with integrated 5-knuckle hinge, padlock ready wire pull, label holder and magnetic catch
- Doors: 0.75" TFL with 6-point adjustable concealed hinge (5-knuckle hinge on folio storage, optional pulls and locks)
- Shelves: 1" medium density fiberboard with radius front, coated on top and front with black Lotz Armor Edge™
- Folio Dividers: 0.1875" hardboard dadoed into cabinet
- Finish: Standard TFL
- Edge Banding: Matching 0.5mm PVC edge banding, 3mm PVC impact areas to reduce chipping
- Base: Integrated, fully finished base with built in levelers adjustable from inside cabinet
- Casters: 3" heavy duty casters, 2 locking, 2 non-locking (only available on folio cabinets and mobile racks) (Casters are NOT to be used as leveling devices and requires field assembly.)



9-gauge solid steel grille doors with pull and label holder



0.75" fully doweled TFL casebody construction



Built-in leveler (standard)



Magnetic catch keeps door closed when lock is removed



Integrated 5-knuckle hinge

TFL Standard Laminate Color Options

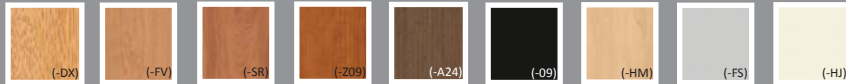

- WB Solar Oak*
- WB Honey Maple*
- WB Oiled Cherry*
- WB American Cherry*
- WB Chestnut Woodline*
- WB Black*
- WB Hardrock Maple*
- WB Folkstone*
- WB Antique White*

*Stocked in limited sizes & quantities. Contact Customer Service for lead time.



Keewaydin Elementary, MN

Recommended Instrument Compartments

Compartment	Inside WxH	23" Deep	29.25" Deep	39.25" Deep
A	8" x 14 7/8"	Clarinet, Flute, Piccolo	2-piece Clarinet Oboe	Bassoon 1-piece Clarinet
B	12 3/8" x 14 7/8"	-----	Alto/Soprano Sax, Cornet, English Horn, Flugelhorn, Trumpet	Tenor Saxophone, Bass Trombone, Trombone, Violin, Viola
C	25 1/2" x 27"	-----	Alto Horn, French Horn, Snare Drum, Orchestra Drum	Baritone Horn, Euphonium, Marching French Horn, Mellophone
D	25 1/2" x 38 5/8"	-----	-----	Bass Drum, Field Drum, Parade Drum
F	25 1/2" x 78 1/4"	-----	Baritone Saxophone, Cello, Contra Alto Clarinet, Contra Bass Clarinet	String Bass
G	25 1/2" x 30 5/8"	-----	Alto Horn, French Horn, Snare Drum, Orchestra Drum	Mellophone, Euphonium, Trombone, Baritone Horn, Marching French Horn
K	8" x 30 5/8"	-----	-----	Guitar
L	8" x 25 1/2"	-----	Oversized: Alto/Soprano Sax Bass Trombone, Cornet/Trumpet English Horn/Flugelhorn	Oversized: Tenor Saxophone Viola Violin

WB's Design Team will work with you from start to finish creating the overall plan for your choral, orchestra or band facilities. Rhapsody® Music Storage units are easily delivered to area schools within 4-6 weeks (project size may extend lead time). Whatever it is that you need to store, WB has a solution that fits your space and budget. Contact our Customer Service Team at 800.242.2303.

A Compartment Cabinets

Model # M1100 Open
M1101 Grille Doors LH
M1102 Grille Doors RH

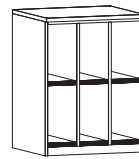

W: 27"
H: 35.625"
D: 23, 29.25 or 39.25"
6 "A" Compartments

Model # M1500 Open
M1501 Grille Doors LH
M1502 Grille Doors RH

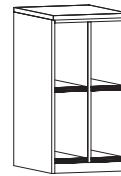

W: 18.25"
H: 35.625"
D: 23, 29.25 or 39.25"
4 "A" Compartments

Model # M2100 Open
M2101 Grille Doors LH
M2102 Grille Doors RH

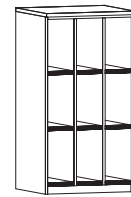

W: 27"
H: 51.5"
D: 23, 29.25 or 39.25"
9 "A" Compartments

Model # M2500 Open
M2501 Grille Doors LH
M2502 Grille Doors RH

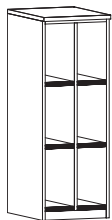

W: 18.25"
H: 51.5"
D: 23, 29.25 or 39.25"
6 "A" Compartments

Model # M3100 Open
M3101 Grille Doors LH
M3102 Grille Doors RH

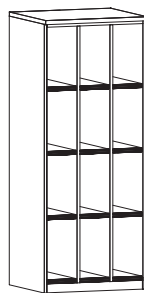

W: 27"
H: 67.375"
D: 23, 29.25 or 39.25"
12 "A" Compartments

Model # M3600 Open
M3601 Grille Doors LH
M3602 Grille Doors RH



W: 18.25"
H: 67.375"
D: 23, 29.25 or 39.25"
8 "A" Compartments

Model # M4100 Open
M4101 Grille Doors LH
M4102 Grille Doors RH

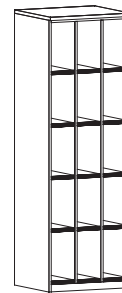

W: 27"
H: 83.25"
D: 23, 29.25 or 39.25"
15 "A" Compartments

Model # M5100 Open
M5101 Grille Doors LH
M5102 Grille Doors RH

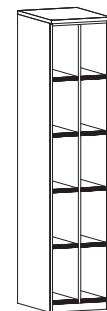

W: 18.25"
H: 83.25"
D: 23, 29.25 or 39.25"
10 "A" Compartments

B Compartment Cabinets

Model # M1200 Open
M1201 Grille Doors LH
M1202 Grille Doors RH

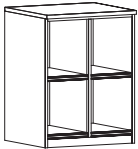

W: 21, 27"
H: 35.625"
D: 23, 29.25 or 39.25"
4 "B" Compartments

Model # M1400 Open
M1401 Grille Doors LH
M1402 Grille Doors RH



W: 13.875"
H: 35.625"
D: 23, 29.25 or 39.25"
2 "B" Compartments

Model # M2200 Open
M2201 Grille Doors LH
M2202 Grille Doors RH

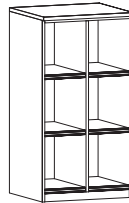

W: 21, 27"
H: 51.5"
D: 23, 29.25 or 39.25"
6 "B" Compartments

Model # M2600 Open
M2601 Grille Doors LH
M2602 Grille Doors RH



W: 13.875"
H: 51.5"
D: 23, 29.25 or 39.25"
3 "B" Compartments

Model # M3200 Open
M3201 Grille Doors LH
M3202 Grille Doors RH

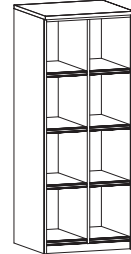

W: 21, 27"
H: 67.375"
D: 23, 29.25 or 39.25"
8 "B" Compartments

Model # M3700 Open
M3701 Grille Doors LH
M3702 Grille Doors RH



W: 13.875"
H: 67.375"
D: 23, 29.25 or 39.25"
4 "B" Compartments

Model # M4200 Open
M4201 Grille Doors LH
M4202 Grille Doors RH



W: 21, 27"
H: 83.25"
D: 23, 29.25 or 39.25"
10 "B" Compartments

Model # M5200 Open
M5201 Grille Doors LH
M5202 Grille Doors RH

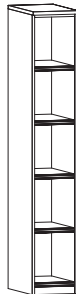

W: 13.875"
H: 83.25"
D: 23, 29.25 or 39.25"
5 "B" Compartments

Depth indicated is casebody dimension.
1" TFL top extends 1" beyond casebody (front edge only). Height includes 1" top.

C and G Compartment Cabinets

Model # M1000 Open
M1001 Grille Doors LH
M1002 Grille Doors RH

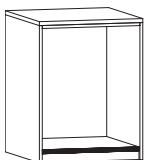

W: 21, 27"
H: 35.625"
D: 23, 29.25 or 39.25"
1 "G" Compartment

Model # M3500 Open
M3501 Grille Doors LH
M3502 Grille Doors RH



W: 21, 27"
H: 67.375"
D: 23, 29.25 or 39.25"
2 "G" Compartments

Model # M4500 Open
M4501 Grille Doors LH
M4502 Grille Doors RH

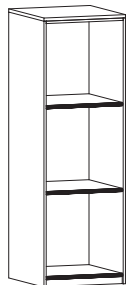

W: 21, 27"
H: 83.25"
D: 23, 29.25 or 39.25"
3 "C" Compartments



Pearson Middle School, MN

D, F, K and L Compartment Cabinets

Model # M4600 Open
M4601 Grille Doors LH
M4602 Grille Doors RH

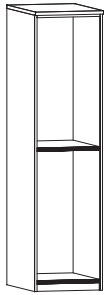

W: 21, 27"
H: 83.25"
D: 23, 29.25 or 39.25"
2 "D" Compartments

Model # M4000 Open
M4001 Grille Doors LH
M4002 Grille Doors RH

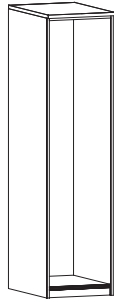

W: 21, 27"
H: 83.25"
D: 23, 29.25 or 39.25"
1 "F" Compartment

Model # M4800 Open
M4801 Grille Doors LH
M4802 Grille Doors RH

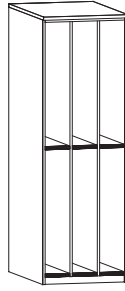

W: 21, 27"
H: 83.25"
D: 23, 29.25 or 39.25"
6 "K" Compartments

Model # M4900 Open
M4901 Grille Doors LH
M4902 Grille Doors RH

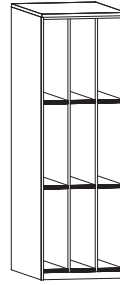

W: 21, 27"
H: 83.25"
D: 23, 29.25 or 39.25"
9 "L" Compartments

Model # M5900 Open
M5901 Grille Doors LH
M5902 Grille Doors RH



W: 18.25"
H: 83.25"
D: 23, 29.25 or 39.25"
6 "L" Compartments

Combination Compartment Cabinets

Model # M2300 Open
M2301 Grille Doors LH
M2302 Grille Doors RH

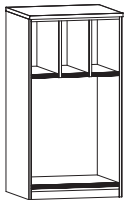

W: 21, 27"
H: 51.5"
D: 23, 29.25 or 39.25"
3 "A" Compartments
1 "G" Compartment

Model # M3300 Open
M3301 Grille Doors LH
M3302 Grille Doors RH

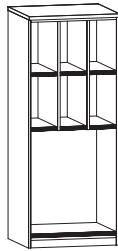

W: 21, 27"
H: 67.375"
D: 23, 29.25 or 39.25"
6 "A" Compartments
1 "G" Compartment

Model # M4300 Open
M4301 Grille Doors LH
M4302 Grille Doors RH

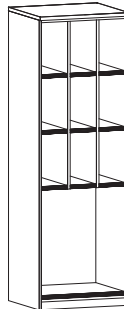

W: 21, 27"
H: 83.25"
D: 23, 29.25 or 39.25"
9 "A" Compartments
1 "G" Compartment

Model # M2400 Open
M2401 Grille Doors LH
M2402 Grille Doors RH

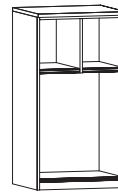

W: 21, 27"
H: 51.5"
D: 23, 29.25 or 39.25"
2 "B" Compartments
1 "G" Compartment

Model # M3400 Open
M3401 Grille Doors LH
M3402 Grille Doors RH

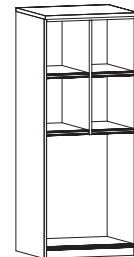

W: 21, 27"
H: 67.375"
D: 23, 29.25 or 39.25"
4 "B" Compartments
1 "G" Compartment

Model # M4400 Open
M4401 Grille Doors LH
M4402 Grille Doors RH

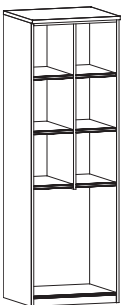

W: 21, 27"
H: 83.25"
D: 23, 29.25 or 39.25"
6 "B" Compartments
1 "G" Compartment

Model # M4920 Open
M4921 Grille Doors LH
M4922 Grille Doors RH



W: 21, 27"
H: 83.25"
D: 23, 29.25 or 39.25"
6 "L" Compartments
1 "C" Compartment

Model # M4820 Open
M4821 Grille Doors LH
M4822 Grille Doors RH

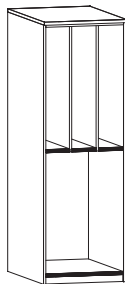

W: 21, 27"
H: 83.25"
D: 23, 29.25 or 39.25"
3 "K" Compartments
1 "D" Compartment

Depth indicated is casebody dimension.
1" TFL top extends 1" beyond casebody (front edge only). Height includes 1" top.

Universal Compartment Cabinets

Model # M6010 open

M6011 grille door LH

M6012 grille door RH

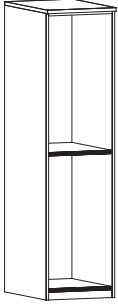

W: 21, 27" H: 83.25"
D: 23, 29.25 or 39.25"
2 compartments
(25.5" x 35.625")
Full height door

Model # M6020 open

M6021 grille door LH

M6022 grille door RH

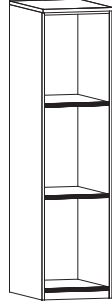

W: 21, 27" H: 83.25"
D: 23, 29.25 or 39.25"
3 compartments
(25.5" x 25.5")
Full height door

Model # M6030 open

M6031 grille door LH

M6032 grille door RH



W: 21, 27" H: 83.25"
D: 23, 29.25 or 39.25"
4 compartments
(25.5" x 18.875")
Full height door

Model # M6040 open

M6041 grille door LH

M6042 grille door RH



W: 21, 27" H: 83.25"
D: 23, 29.25 or 39.25"
5 compartments
(25.5" x 14.9")
Full height door

Model # M6050 open

M6051 grille door LH

M6052 grille door RH

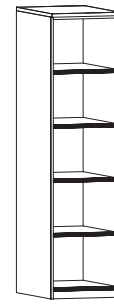

W: 21, 27" H: 83.25"
D: 23, 29.25 or 39.25"
6 compartments
(25.5" x 12.25")
Full height door

Model # M6110KD open

M6113KD grille dbl doors

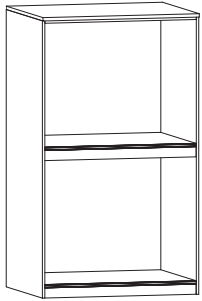

W: 48"
H: 83.25"
D: 23, 29.25 or 39.25"
2 compartments
(46.5" x 35.625")
Full height double doors
D: 39.25"-ships knocked down

Model # M6120KD open

M6123KD grille dbl doors

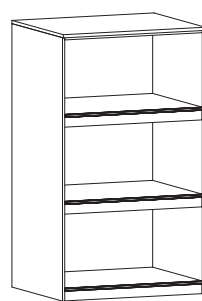

W: 48"
H: 83.25"
D: 23, 29.25 or 39.25"
3 compartments
(46.5" x 22.625")
Full height double doors
D: 39.25"-ships knocked down

Model # M6130KD open

M6133KD grille dbl doors

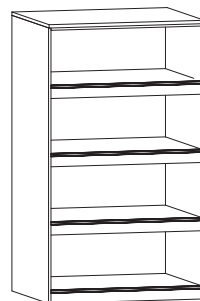

W: 48"
H: 83.25"
D: 23, 29.25 or 39.25"
4 compartments
(46.5" x 15.75")
Full height double doors
D: 39.25"-ships knocked down

Model # M6140KD open

M6143KD grille dbl doors

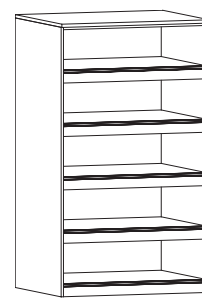

W: 48"
H: 83.25"
D: 23, 29.25 or 39.25"
5 compartments
(46.5" x 11.625")
Full height double doors
D: 39.25"-ships knocked down

Model # M6210KD open

M6213KD grille dbl doors

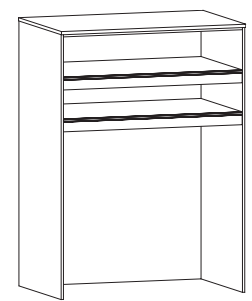

W: 60" H: 83.25"
D: 39.25"
3 compartments
(58.5" x 8.25"; 58.5" x 13.25"; 58.5" x 52.375")
Roll-in storage (no base)
Full height double doors
Ships knocked down

Model # M6310KD open

M6313KD grille dbl doors



W: 60"
H: 83.25"
D: 39.25"
Stringed instrument cabinet
Padded support bars
Full height double doors
Ships knocked down



Folio Storage

Sheet Music Solutions

Keep all your folios organized and easily accessible with our selection of Folio Cabinets of 50, 75 and 100 shelves, with or without doors and locks. Optional casters make these cabinets portable so you can take your choral, band or orchestra sheet music anywhere. See pages 154-155 for our innovative high density music library system.



3/16" hardboard shelves dadoed into cabinet with 1.5" spacing



3" heavy duty casters, 2 locking, 2 non-locking (optional)



Units with doors feature contemporary pulls and 5-knuckle hinges (optional lock)

encore

Uniform Storage

Uniform Solutions

Secure, breathable space is necessary when protecting large investments of uniforms and robes. No matter what type or how many hats and garments you need to store, WB Manufacturing has a wide assortment of solutions to suit your needs and budget. Available as an open cabinet or with wire grille or laminate doors, with and without shelves.



Chrome garment rods



Built-in levelers



Stringed Instrument Mobile Storage Rack

Mobile Strings

Durable, portable protection for your most fragile instruments using 1" solid thermal fused laminate construction with high impact edge banding, 3" heavy duty casters and chrome bow hooks. Store, protect and transport violins, violas, cellos and basses safely with these mobile units. Smooth rolling design allows for easy transport through doorways from practice halls to rehearsal and performance areas.



3" heavy duty casters, 4 locking



1/4" thick chenille strip to protect instrument finish



Vinyl T-mold protects instrument necks

Mobile Percussion Station

Keeping the Beat

Transport all your percussion instruments from rehearsal halls to performance venues in this mobile workstation.

Large chenille lined 50" x 23 3/4" top surface silences instruments not in use and four chenille lined drawers keep triangles, sand blocks, brushes, drumsticks, mallets, maracas, tambourines, cow bells and other smaller items organized. Lower compartments are large enough to store parade and snare drums and shelves accommodate the largest standard-size cymbals. Integrated locks on doors keep instruments secure and music stands flat when not in use. Heavy duty 3" casters glide over multiple surfaces easily.

Percussion cymbal stands and cymbal cradles are available upon request and attach easily to sides of percussion station top.



Flip-up music stand



Chenille lined top provides ample room for performance day



Heavy duty casters, 2 locking, 2 non-locking



Side-mount full extension steal drawer glides

Folio Storage Cabinets

Model #	Description	WxDxH
M7500	50 Opening w/Hardboard Shelves, w/o Doors, Levelers	28" x 18" x 54"
M7500-AC	50 Opening w/Hardboard Shelves, w/o Doors, Casters	28" x 18" x 54"
M7503	50 Opening w/Hardboard Shelves, w/Doors, Levelers	28" x 18" x 54"
M7503-AC	50 Opening w/Hardboard Shelves, w/Doors, Casters	28" x 18" x 54"
M7750	75 Opening w/Hardboard Shelves, w/o Doors, Levelers	41" x 18" x 54"
M7750-AC	75 Opening w/Hardboard Shelves, w/o Doors, Casters	41" x 18" x 54"
M7753	75 Opening w/Hardboard Shelves, w/Doors, Levelers	41" x 18" x 54"
M7753-AC	75 Opening w/Hardboard Shelves, w/Doors, Casters	41" x 18" x 54"
M71000	100 Opening w/Hardboard Shelves, w/o Doors, Levelers	54" x 18" x 54"
M71000-AC	100 Opening w/Hardboard Shelves, w/o Doors, Casters	54" x 18" x 54"
M71003	100 Opening w/Hardboard Shelves, w/Doors, Levelers	54" x 18" x 54"
M71003-AC	100 Opening w/Hardboard Shelves, w/Doors, Casters	54" x 18" x 54"



Uniform and Garment Storage Cabinets

Grille LH	Grille RH	Door LH	Door RH	Open	Rods	Shelves	WxDxH
M6401	M6402	M6403	M6404	M6400	2	0	27" x 29.25" x 83.25"
M6501	M6502	M6503	M6404	M6500	1	1	27" x 29.25" x 83.25"
M6601	M6402	M6603	M6604	M6600	1	3	27" x 29.25" x 83.25"

Grille Dbl Door	Double Door	Open	Rods	Shelves	WxDxH
M6701	M6703	M6700	2	0	48" x 29.25" x 83.25"
M6801	M6803	M6800	1	1	48" x 29.25" x 83.25"
M6901	M6903	M6900	1	3	48" x 29.25" x 83.25"



Stringed Instrument Mobile Storage Racks*

Model #	Description	WxDxH
MSRC-4	4 Position Cello, Casters	50" x 26" x 48"
MSRC-6	6 Position Cello Unit, Casters	74" x 26" x 48"
MSRB-3	3 Position Bass Unit, Casters	61" x 26" x 62"
MSRB-4	4 Position Bass Unit, Casters	84" x 26" x 62"
MSRV-16	16 Position Viola Unit, Casters	74" x 30" x 57"

*Racks are shipped knocked down.



Mobile Percussion Cart

Model #	Description	WxDxH
MPWS-AC	Mobile Percussion Cart	50" x 25" x 42"



We Can.
DESIGN. BUILD. DELIVER.





Marshfield High School

Marshfield, MA

When TriState Contract Sales needed music storage for Marshfield Massachusetts' new high school, they came to WB Manufacturing for their quality-constructed, budget minded Rhapsody® lineup of music cabinets. When TriState also needed high-density storage, We Can was the answer from the WB Design Team. Now, the custom, created-from-scratch, high-density storage created for Marshfield High School is a standard in the WB Manufacturing catalog. See pages 154-155 for details.





Modular Casework

from WB Manufacturing

Solve changing demographics, repurposed workspaces or fluctuations in populations with repositionable, modular cabinets. Gain immediate return on investment with freestanding cabinets with built-in levelers and attached countertops, which means no costly installation fees, little or no down time and no future facility repairs. Repositionable REplay® series furniture can be reused, extending the life of the product indefinitely. Recycle cabinets into new configurations, rooms or buildings, reducing environmental impact. REplay® cabinets are constructed with all finished edges, which reduce VOCs emitted through the air. Finished edges also eliminate the risk of mold growth on exposed particle board core material. Ten year warranty. Don't repay for casework, REplay®.



REplay® Cabinet

Standard and Custom Solutions

Completely finished back and toe kick and built-in levelers allow cabinets to be installed like furniture, leaving walls and flooring untouched, minimizing labor and remodeling costs. Our Select REplay® Cabinets feature a TFL case and your choice of TFL top so you can customize your cabinets to fit your environment. Cabinets arrive fully assembled, ready to set in place and use.

REplay®



flexible spaces,
modular storage
solutions

REplay® Cabinet Overview

- Case: Fully doweled 0.75" double-sided thermal fused laminate (TFL)
- Countertop: 1" thermal fused laminate(TFL) top over 0.75" TFL subtop (HPL top is optional)
- Drawers: Fully doweled 0.5" white box and subfront with 0.75" TFL front, contemporary pull (brushed chrome is standard)
- Drawer Glides: Standard 0.75" undermount (file drawers have full extension side mount steel ball bearing glide)
- Doors: 0.75" TFL with contemporary pulls
- Hinges: 6-point adjustable concealed hinge
- Shelves: TFL (fixed are fully doweled, adjustable have 4 double-pin shelf clips)
- Finish: Standard TFL on cases, standard or custom HPL on countertops
- Edge Banding: Matching 0.5mm PVC edge banding, 3mm PVC on doors, drawer fronts and countertop
- Base: Integrated, fully finished base with built in levelers adjustable from inside cabinet (hidden caster/leveler option)
- Casters: 3" heavy duty casters, 2 locking, 2 non-locking (only available on selected REplay® units) (Casters are NOT to be used as leveling devices and requires field assembly.)



*Stocked in limited sizes & quantities. Contact Customer Service for lead time.

RB9215

Repositionable REplay® furniture can be reused, extending the life of the product indefinitely. The built-in levelers allow cabinets to be installed with very little installation cost and can be moved around at your free will.

RB2400 (See page 143 for inside view)

RT3232 RT4224 (See page 146 for inside views)

Open Base Cabinets

Model # RB1140



W: 30, 33 or 36"
H: 34"
D: 23"
1 Adjustable Shelf

Model # RB1150



W: 30, 33 or 36"
H: 34"
D: 23"
2 Adjustable Shelves

Model # RB1110

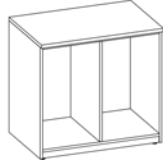

W: 30, 33, 36, 39, 42 or 48"
H: 34"
D: 23"
1 Vertical Divider

Model # RB1120

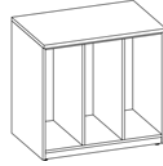

W: 30, 33, 36, 39, 42 or 48"
H: 34"
D: 23"
2 Vertical Dividers

Model # RB1145



W: 30, 33, 36, 39, 42 or 48"
H: 34"
D: 23"
1 Vertical Divider
2 Adjustable Shelves

Model # RB1155



W: 30, 33, 36, 39, 42 or 48"
H: 34"
D: 23"
1 Vertical Divider
4 Adjustable Shelves

Model # RB1146



W: 30, 33, 36, 39, 42 or 48"
H: 34"
D: 23"
2 Vertical Dividers
3 Adjustable Shelves

Model # RB1165



W: 30, 33, 36, 39, 42 or 48"
H: 34"
D: 23"
2 Vertical Dividers
6 Adjustable Shelves

Model # RB1136



W: 30, 33, 36, 39, 42 or 48"
H: 34"
D: 23"
3 Vertical Dividers
4 Adjustable Shelves

Model # RB1175

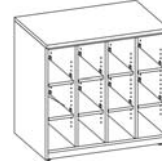

W: 30, 33, 36, 39, 42 or 48"
H: 34"
D: 23"
3 Vertical Dividers
8 Adjustable Shelves

Double Sided Bookcase

Model # RB1190

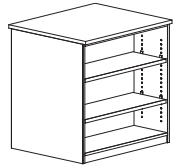

W: 36"
H: 36"
D: 28"
2 Adjustable Shelves per side

Door and Drawer Cabinets

Model # RB3000/RB3005

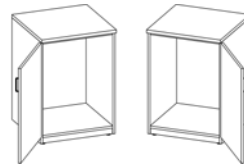

W: 15, 18, 21 or 24"
H: 34"
D: 23"
Left/Right Hinge

Model # RB3010/RB3015

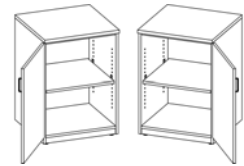

W: 15, 18, 21 or 24"
H: 34"
D: 23"
Left/Right Hinge
1 Adjustable Shelf

Model # RB3110/RB3120



W: 15, 18, 21 or 24"
H: 34"
D: 23"
Left/Right Hinge
2 Adjustable Shelves

Model # RB3200/RB3205

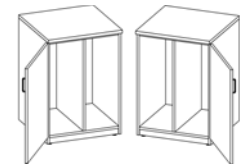

W: 15, 18, 21 or 24"
H: 34"
D: 23"
Left/Right Hinge
1 Vertical Divider

Model # RB3210/RB3215

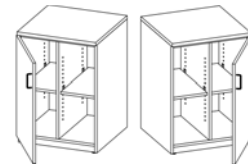

W: 15, 18, 21 or 24"
H: 34"
D: 23"
Left/Right Hinge, 1 Vertical
Divider, 2 Adjustable Shelves

Model # RB3815/RB3825

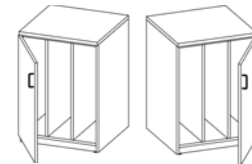

W: 15, 18, 21 or 24"
H: 34"
D: 23"
Left/Right Hinge
2 Vertical Dividers

Model # RB3230/RB3235

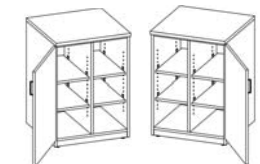

W: 15, 18, 21 or 24"
H: 34"
D: 23"
Left/Right Hinge, 1 Vertical
Divider, 4 Adjustable Shelves

Depth indicated is casebody dimension.
1" HPL top extends 1" beyond casebody (front
side only). Height includes 1" top.

Model # RB3835/RB3836

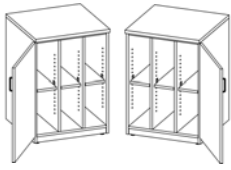

W: 15, 18, 21 or 24"
H: 34"
D: 23"
Left/Right Hinge, 2 Vertical Dividers, 3 Adjustable Shelves

Model # RB3865/RB3866

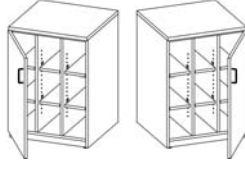

W: 15, 18, 21 or 24"
H: 34"
D: 23"
Left/Right Hinge, 2 Vertical Dividers, 6 Adjustable Shelves

Model # RB3100

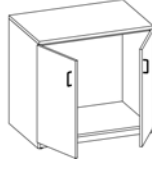

W: 30, 33, or 36"
H: 34"
D: 23"
Double Doors

Model # RB3112



W: 30, 33 or 36"
H: 34"
D: 23"
Double Doors, 1 Adjustable Shelf

Model # RB3122



W: 30, 33 or 36"
H: 34"
D: 23"
Double Doors, 2 Adjustable Shelves

Model # RB3101



W: 30, 33, 36, 39, 42 or 48"
H: 34"
D: 23"
Double Doors, 1 Vertical Divider

Model # RB3145

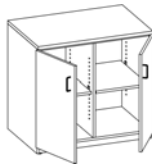

W: 30, 33, 36, 39, 42 or 48"
H: 34"
D: 23"
Double Doors, 1 Vertical Divider, 2 Adjustable Shelves

Model # RB3155



W: 30, 33, 36, 39, 42 or 48"
H: 34"
D: 23"
Double Doors, 1 Vertical Divider, 4 Adjustable Shelves

Model # RB3135

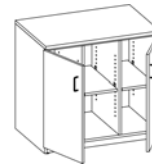

W: 30, 33, 36, 39, 42 or 48"
H: 34"
D: 23"
Double Doors, 2 Vertical Dividers, 3 Adjustable Shelves

Model # RB3165



W: 30, 33, 36, 39, 42 or 48"
H: 34"
D: 23"
Double Doors, 2 Vertical Dividers, 6 Adjustable Shelves

Model # RB2100/RB2105



W: 15, 18, 21 or 24"
H: 34"
D: 23"
Single Drawer Over Door, Left/Right Hinge

Model # RB2110/RB2120

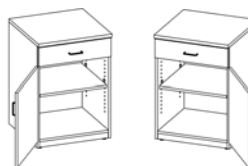

W: 15, 18, 21 or 24"
H: 34"
D: 23"
Single Drawer Over Door, Left/Right Hinge, 1 Adjustable Shelf

Model # RB2210

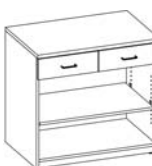

W: 30, 33 or 36"
H: 34"
D: 23"
Double Drawers Over Open, 1 Adjustable Shelf

Model # RB2404



W: 30, 33, 36, 39, 42 or 48"
H: 34"
D: 23"
Double Drawers Over Open, 1 Vertical Divider

Model # RB2405



W: 30, 33, 36, 39, 42 or 48"
H: 34"
D: 23"
Double Drawers Over Open, 1 Vertical Divider, 2 Adjustable Shelves

Model # RB2400



W: 30, 33 or 36"
H: 34"
D: 23"
Double Drawers Over Double Doors, 1 Adjustable Shelf

Model # RB2402



W: 30, 33, 36, 39, 42 or 48"
H: 34"
D: 23"
Double Drawers Over Double Doors, 1 Vertical Divider

Model # RB2425



W: 30, 33, 36, 39, 42 or 48"
H: 34"
D: 23"
Double Drawers Over Double Doors, 1 Vertical Divider, 2 Adjustable Shelves

Model # RB2403



W: 30, 33, 36, 39, 42 or 48"
H: 34"
D: 23"
Double Drawers Over Double Doors, 2 Vertical Dividers

Model # RB2426



W: 30, 33, 36, 39, 42 or 48"
H: 34"
D: 23"
Double Drawers Over Double Doors, 2 Vertical Dividers, 3 Adjustable Shelves

Drawer Base Cabinets

Model # RB6030



W: 30, 33 or 36"
H: 34"
D: 23"
3 Equal Drawers

Model # RB6040



W: 30, 33 or 36"
H: 34"
D: 23"
4 Standard Drawers

Model # RB6035



W: 30, 33 or 36"
H: 34"
D: 23"
1 Standard 6.125" Drawer,
2 Equal Drawers

Model # RB6045



W: 30, 33 or 36"
H: 34"
D: 23"
1 Standard 6.125" Drawer,
3 Equal Drawers

Model # RB9205



W: 15.75 or 18.75"
H: 30"
D: 23"
1 Single 6.125" Drawer,
1 Single Drawer (Balance),
1 File Drawer

Model # RB9206



W: 15.75 or 18.75"
H: 30"
D: 23"
Pull Out Shelf, 1 Single 4.5"
Drawer, 1 Single Drawer
(Balance), 1 File Drawer

Model # RB9200



W: 15.75 or 18.75"
H: 30"
D: 23"
2 File Drawers

Model # RB9230

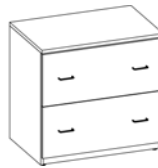

W: 24, 30 or 36"
H: 30"
D: 23"
2 Lateral File Drawers

Model # RB9210



W: 15.75 or 18.75"
H: 42"
D: 23"
3 File Drawers

Model # RB9215

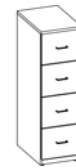

W: 15.75 or 18.75"
H: 54"
D: 23"
4 File Drawers

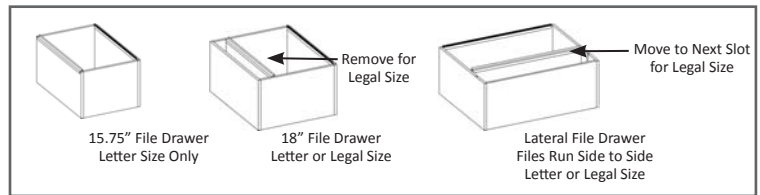

Sliding Door Base Cabinets

Model # RB3405



W: 30, 33 or 36"
H: 34"
D: 23"
1 Adjustable Shelf

Model # RB3410

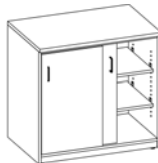

W: 30, 33 or 36"
H: 34"
D: 23"
2 Adjustable Shelves

Model # RB3406

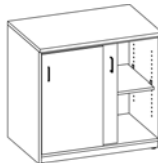

W: 30, 33, 36, 39, 42 or 48"
H: 34"
D: 23"
1 Vertical Divider,
2 Adjustable Shelves

Model # RB3411

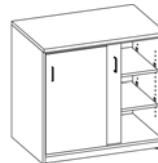

W: 30, 33, 36, 39, 42 or 48"
H: 34"
D: 23"
1 Vertical Divider,
4 Adjustable Shelves

Sink Base Cabinets

Model # RB4110/RB4120

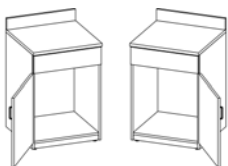

W: 15, 18, 21 or 24"
H: 34"
D: 23"
Blank Panel,
Door, Left/Right Hinge

Model # RB4010/RB4020

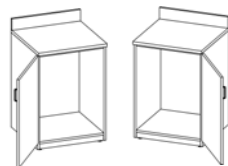

W: 15, 18, 21 or 24"
H: 34"
D: 23"
Full Height Door,
Left/Right Hinge

Model # RB4102



W: 30, 33, 36, 39, 42 or 48"
H: 34"
D: 23"
Blank Panel,
Double Doors

Model # RB4002

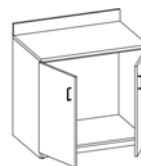

W: 30, 33, 36, 39, 42 or 48"
H: 34"
D: 23"
Full Height Double Doors

Depth indicated is casebody dimension.
1" HPL top extends 1" beyond casebody
(front side only). Height includes 1" top.

Tech Base Cabinets

Model # RSB301



W: 30"
H: 29"
D: 30"
Tech Cabinet, 3 Drawers Left,
Open Right, Cutout
Back Panel

Model # RSB303



W: 30"
H: 29"
D: 30"
Tech Cabinet, 3 Drawers Left,
Open Right, Cutout Right
Side Panel

Model # RSB302



W: 30"
H: 29"
D: 30"
Tech Cabinet, 3 Drawers Right,
Open Left, Cutout
Back Panel

Model # RSB304



W: 30"
H: 29"
D: 30"
Tech Cabinet, 3 Drawers Right,
Open Left, Cutout
Right Side Panel

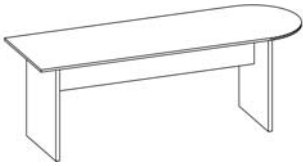

Model #	Description	Desk Height
RD0000-48	Universal Desk 48"W x 30"D	29"
RD0001-60	Universal Desk 60"W x 30"D	29"
RD0002-72	Universal Desk 72"W x 30"D	29"
RD0003-84	Universal Desk 84"W x 30"D	29"

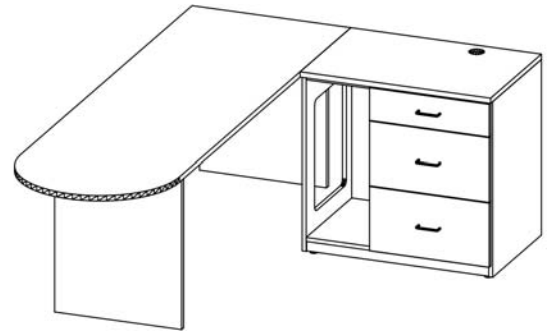

RD0000-48 & RSB304
shown



Raymore/Peculiar, MO

Tall Cabinets

Model # RT1250

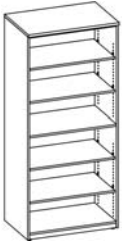

W: 24, 30, 33 or 36"
H: 72 or 84" D: 28"
Open, 1 Center Fixed Shelf,
4 Adjustable Shelves
(72") / 4 (84")

Model # RT1255



W: 24, 30, 33, 36 or 48"
H: 72 or 84" D: 28"
Open, 1 Vertical Divider, 2
Fixed Shelves, 8 Adjustable
Shelves (72") / 8 (84")

Model # RT1251

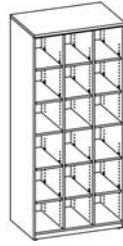

W: 24, 30, 33, 36 or 48"
H: 72 or 84" D: 28"
Open, 2 Vertical Dividers,
3 Fixed Shelves, 12 Adjustable
Shelves (72") / 12 (84")

Model # RT1252

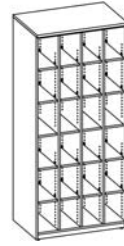

W: 24, 30, 33, 36 or 48"
H: 72 or 84" D: 28"
Open, 3 Vertical Dividers, 4
Fixed Shelves, 16 Adjustable
Shelves (72") / 16 (84")

Model # RT3232



W: 24, 30, 33 or 36"
H: 72 or 84" D: 28"
Double Doors, 1 Fixed Shelf,
4 Adjustable Shelves (72") /
4 (84")

Model # RT3105

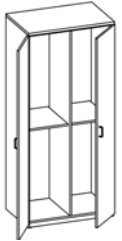

W: 24, 30, 33, 36 or 48"
H: 72 or 84"
D: 28"
Double Doors
1 Vertical Divider
2 Fixed Shelves

Model # RT3110

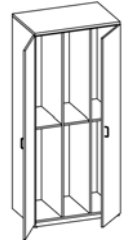

W: 24, 30, 33, 36 or 48"
H: 72 or 84"
D: 28"
Double Doors
2 Vertical Dividers
3 Fixed Shelves

Model # RT3222



W: 24, 30, 33, 36 or 48"
H: 72 or 84" D: 28"
Double Doors, 1 Vertical
Divider, 2 Fixed Shelves,
8 Adjustable Shelves (72") /
8 (84")

Model # RT3165

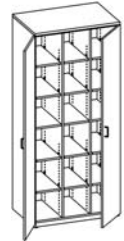

W: 24, 30, 33, 36 or 48"
H: 72 or 84" D: 28"
Double Doors, 2 Vertical
Dividers, 3 Fixed Shelves,
12 Adjustable Shelves (72") /
12 (84")

Model # RT3200/RT3201

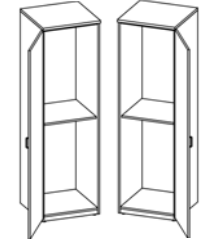

W: 15, 18, 21 or 24"
H: 72 or 84" D: 28"
Single Door, Left/Right Hinge,
1 Fixed Shelf

Model # RT3210/RT3220

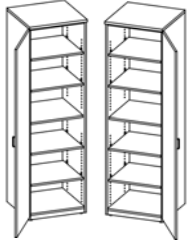

W: 15, 18, 21 or 24"
H: 72 or 84"
D: 28"
Single Door, Left/Right Hinge,
1 Fixed Shelf, 4 Adjustable
Shelves (72") / 4 (84")

Model # RT3225/RT3235

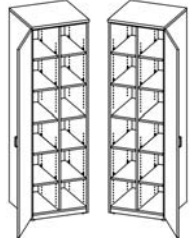

W: 15, 18, 21 or 24"
H: 72 or 84" D: 28"
Single Door, Left/Right Hinge,
1 Vertical Divider, 2 Fixed
Shelves, 8 Adjustable Shelves
(72") / 8 (84")

Model # RT4110/RT4120



W: 15, 18, 21 or 24"
H: 72 or 84"
D: 28"
Single Door Wardrobe, Left/
Right Hinge, 1 Fixed Shelf,
1 Clothing Rod

Model # RT4100

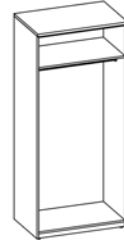

W: 24, 30, 33 or 36"
H: 72 or 84"
D: 28"
Open Wardrobe
1 Fixed Shelf
1 Clothing Rod

Model # RT4122

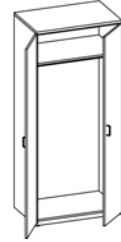

W: 24, 30, 33 or 36"
H: 72 or 84"
D: 28"
Double Door Wardrobe
1 Fixed Shelf
1 Clothing Rod

Model # RT4222/RT4224

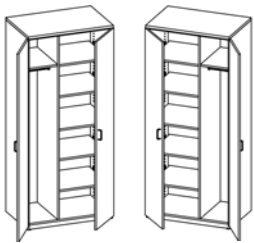

W: 24, 30, 33 or 36"
H: 72 or 84" D: 28"
Teachers Wardrobe, 1 Vertical
Divider, Left or Right: 2 Fixed
Shelf, 1 Clothing Rod, 4
Adjustable Shelves (72") / 4
(84"), Mirror

Depth indicated is casebody dimension.
1" TFL top extends 1" beyond casebody (front
side only). Height includes 1" top.

Mobile Open Base Cabinets

Model # CRB1140



W: 30 or 36"
H: 34"
D: 23"
1 Adjustable Shelf, Casters

Model # CRB1150



W: 30 or 36"
H: 34"
D: 23"
2 Adjustable Shelves, Casters

Model # CRB1145



W: 30, 36, 42 or 48"
H: 34"
D: 23"
1 Vertical Divider
2 Adjustable Shelves, Casters

Model # CRB1155



W: 30, 36, 42 or 48"
H: 34"
D: 23"
1 Vertical Divider
4 Adjustable Shelves, Casters

Model # CRB1146



W: 30, 36, 42 or 48"
H: 34"
D: 23"
2 Vertical Dividers
3 Adjustable Shelves, Casters

Mobile Bookcase Double Sided

Model # CRB1165



W: 30, 36, 42 or 48"
H: 34"
D: 23"
2 Vertical Dividers
6 Adjustable Shelves, Casters

Model # CRB1190

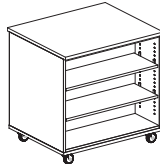

W: 36"
H: 36"
D: 28"
2 Adjustable Shelves(per side), Casters

Mobile Curved Bookcases Single Sided

Model # CRB2190



W: 38.375"
H: 48"
D: 21"
2 Fixed Shelves, Casters, Magnet Docking

Model # CRB2195



W: 38.375"
H: 48"
D: 24"
2 Fixed Shelves(per side), Casters, Magnet Docking

Mobile Door and Drawer Cabinets

Model # CRB3010/CRB3015



W: 24"
H: 34"
D: 23"
Left/Right Hinge
1 Adjustable Shelf, Casters

Model # CRB3110/CRB3120



W: 24"
H: 34"
D: 23"
Left/Right Hinge
2 Adjustable Shelves, Casters

Model # CRB3112



W: 30 or 36"
H: 34"
D: 23"
Double Doors,
1 Adjustable Shelf, Casters

Model # CRB3122



W: 30 or 36"
H: 34"
D: 23"
Double Doors,
2 Adjustable Shelves, Casters

Model # CRB3145



W: 30, 36, 42 or 48"
H: 34"
D: 23"
Double Doors, 1 Vertical
Divider, 2 Adjustable Shelves,
Casters

Model # CRB3155



W: 30, 36, 42 or 48"
H: 34"
D: 23"
Double Doors, 1 Vertical
Divider, 4 Adjustable Shelves,
Casters

Model # CRB3135



W: 30, 36, 42 or 48"
H: 34"
D: 23"
Double Doors, 2 Vertical
Dividers, 3 Adjustable Shelves,
Casters

Model # CRB3165



W: 30, 36, 42 or 48"
H: 34"
D: 23"
Double Doors, 2 Vertical
Dividers, 6 Adjustable Shelves,
Casters

Model # CRB2100/CRB2105



W: 24"
H: 34"
D: 23"
Single Drawer Over Door,
Left/Right Hinge
Casters

Model # CRB2110/CRB2120



W: 24"
H: 34"
D: 23"
Single Drawer Over Door,
Left/Right Hinge
1 Adjustable Shelf, Casters

Depth indicated is casebody dimension.
1" HPL top extends 1" beyond casebody (front
side only). Height includes 1" top.

Mobile Door and Drawer Cabinets

Model # CRB2210



Model # CRB2405



Model # CRB2400



W: 30 or 36"
H: 34"
D: 23"
Double Drawers Over Open,
1 Adjustable Shelf, Casters

W: 30, 36, 42 or 48"
H: 34"
D: 23"
Double Drawers Over Open,
1 Vertical Divider
2 Adjustable Shelves, Casters

W: 30, 33 or 36"
H: 34"
D: 23"
Double Drawers Over Double
Doors, 1 Adjustable Shelf,
Casters

Mobile Drawer Base Cabinets

Model # CRB6030



Model # CRB6040



Model # CRB6035



Model # CRB6045



W: 30 or 36"
H: 34"
D: 23"
3 Equal Drawers, Casters

W: 30 or 36"
H: 34"
D: 23"
4 Standard Drawers, Casters

W: 30 or 36"
H: 34"
D: 23"
1 Standard 6.125" Drawer,
2 Equal Drawers, Casters

W: 30 or 36"
H: 34"
D: 23"
1 Standard 6.125" Drawer,
3 Equal Drawers, Casters

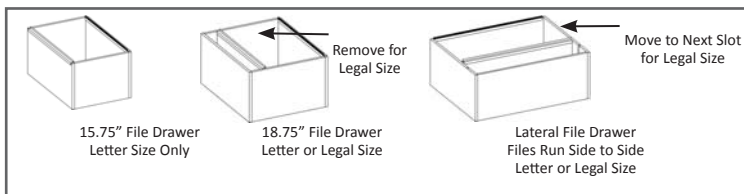

Depth indicated is casebody dimension.
1" HPL top extends 1" beyond casebody
(front side only). Height includes 1" top.







We Can.

DESIGN. BUILD. DELIVER.

Southview Elementary

Chippewa Falls, WI

When Scholastic Equipment Co. saw the bid for the Southview Elementary media center, they knew that a We Can attitude was needed to meet the modular, mobile and casework requirements of the facility. Scholastic Equipment Co. turned to WB Manufacturing for a completely custom, modular circulation desk and mobile book carts, all the while utilizing WB's REplay® standard lineup to meet their modular shelving needs.



iXchange Learning Wall System

Learning Storage

Traditional whiteboard walls now become

attractive, valuable storage space. Expand the functionality of the classroom with REplay® modular base and top cabinets that can be easily disassembled and reassembled for cleaning or relocation. The information eXchange wall is the perfect solution for all conference rooms, classrooms, training centers and boardrooms.



exchange

iXchange Learning Wall Systems

Model #	Description	WxDxH
SSW0801	8' iXchange Wall System -- 2 x 48" open w/shelves/dividers base units; 2 x 48" wall hutch units w/adjustable shelves; 2 porcelain whiteboards	96" x 24" x 84"
SSW0802	8' iXchange Wall System -- 2 x 48" 2-door base units; 2 x 48" wall hutch units w/adjustable shelves; 2 porcelain whiteboards	96" x 24" x 84"
SSW1001	10' iXchange Wall System -- 2 x 30" 2-door and 2 x 30" open w/shelves/dividers base units; 2 x 36" and 1 x 48" wall hutch w/adjustable shelves; 2 porcelain whiteboards	120" x 24" x 84"
SSW1002	10' iXchange Wall System -- 2 x 30" 2-door and 2 x 30" 2-door/2-drawer base units; 2 x 36" and 1 x 48" wall hutch w/adjustable shelves; 2 porcelain whiteboards	120" x 24" x 84"
SSW1201	12' iXchange Wall System -- 3 x 48" 2-door base units; 3 x 48" wall hutch units w/adjustable shelves; 2 porcelain whiteboards	144" x 24" x 84"
SSW1202	12' iXchange Wall System -- 2 x 36" 2-door and 2 x 36" 2-door/2-drawer base units; 4 x 36" wall hutch units w/adjustable shelves; 2 porcelain whiteboards	144" x 24" x 84"
SSW1203	12' iXchange Wall System -- 3 x 48" open w/shelves/dividers base units; 3 x 48" wall hutch units w/adjustable shelves; 2 porcelain whiteboards	144" x 24" x 84"



SSW0801

SSW0802

SSW1001

SSW1002

SSW1201

SSW1202

SSW1203

iXchange Learning Wall System Overview

- Case: Fully doweled 0.75" double-sided thermal fused laminate (TFL) with matching top over 0.75" subtop
- Drawers: Fully doweled 0.5" white box with 0.75" TFL front, contemporary pulls
- Drawer Glides: Standard 0.75" undermount
- Doors: 0.75" TFL with contemporary pulls
- Hinges: 6-point adjustable concealed hinge
- Shelves: TFL (fixed are fully doweled, adjustable have 4 double-pin shelf clips)
- Finish: Standard TFL or custom laminate
- Edge Banding: Matching 0.5mm PVC edge banding, 3mm PVC on doors, drawer fronts and top
- Base: Integrated, fully finished base with built in levelers adjustable from inside cabinet (optional hidden casters)
- Whiteboards: Magnetic porcelain coated steel, aluminum trim, cork map rail and marker tray (2 boards standard, optional third and locking boards available)



Shelves and double-pin clips



Built-in levelers (standard)



Contemporary pulls and integrated locks (optional)

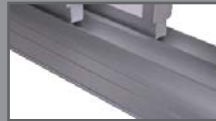

Aluminum marker tray integrated into whiteboard frame



Porcelain coated steel magnetic whiteboard with aluminum frame



Integrated cork map rail

TFL Standard Laminate Color Options



WB Solar Oak*



WB Honey Maple*



WB Oiled Cherry*



WB American Cherry*



WB Chestnut Woodline*



WB Black*



WB Hardrock Maple*



WB Folkstone*



WB Antique White*



Complete Laminate Collections Available

*Stocked in limited sizes & quantities. Contact Customer Service for lead time.





High Density Storage

Space Saving Solutions

WB Manufacturing's high density storage units provide solutions for storing active records, media, files, library books, sheet music and general supplies as well as athletic equipment, museum specimens, art collections and more. Sleek design fits into small spaces and pull-out shelving units require no aisle space for accessing materials. High density roll-out design saves on valuable floor space, storing more in 50% less space than lateral files, traditional filing cabinets or shelving. Laminate cabinets can be completely customized to meet your storage requirements.

volume

High Density Storage

1. 3/4" fully doweled cabinet body
2. Matching top
3. 3/4" matching finishing panel
4. Contemporary pull and label holder
5. Matching shelves (fixed fully doweled, adjustable have 4 double-pin shelf clips)
6. Heavy duty, 10-gauge steel roller base
7. 6" smooth rolling wheels
8. 4" v-groove casters
9. 1/4" steel floor mount track plate*
10. Joint connector bolts attach cabinet to roller base
11. 15 1/2"W x 48 1/4"D x 84 3/8"H unit dimensions

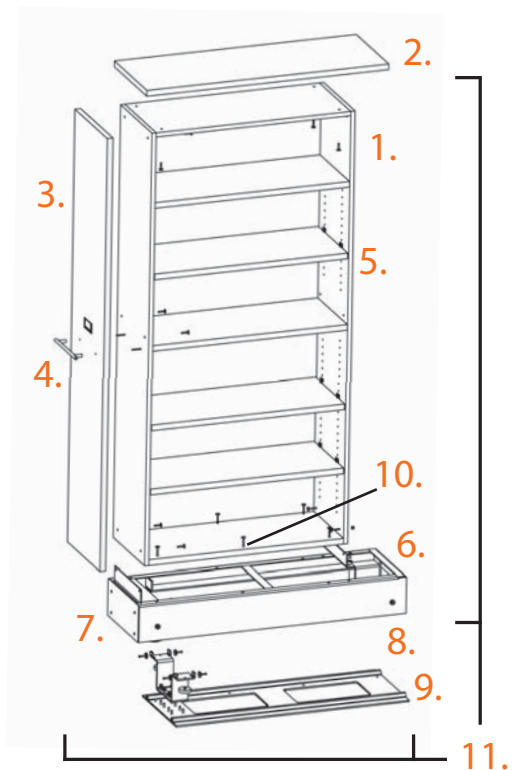

*Hardware to attach plate to floor is not included. Mounting high density storage units to a carpeted floor is not recommended unless carpet is commercial grade without a foam pad. If floor level varies by more than 1/8" over a 3' span, installation in another location is recommended. (Find assembly instructions at www.wibenchmfg.com).

High Density Storage Overview

- Case: Fully doweled 0.75" double-sided thermal fused laminate (TFL) with matching top over 0.75" subtop
- Shelves: Matching TFL, 2 fixed, 3 adjustable (fixed are fully doweled, adjustable have 4 double-pin shelf clips)
- Finish: Standard or custom laminate
- Edge Banding: Matching 0.5mm PVC, 3mm PVC on front and top
- Base: Steel frame base features heavy duty casters to support load and glides along track secured to the floor
- Pulls: Contemporary pulls



Heavy duty roll out base system



Contemporary pulls



Label holder (optional)

TFL Standard Laminate Color Options



WB Solar Oak*



WB Honey Maple*



WB Oiled Cherry*



WB American Cherry*



WB Chestnut Woodline*



WB Black*



WB Hardrock Maple*



WB Folkstone*



WB Antique White*

*Stocked in limited sizes & quantities. Contact Customer Service for lead time.

Model #	Description	WxDxH
SSHD5000	5 Shelves, Roll-Out Caster System	48" x 16" x 72"
SSHD6000	6 Shelves, Roll-Out Caster System	48" x 16" x 84"
SSHD7000	7 Shelves, Roll-Out Caster System	48" x 16" x 92"



Marshfield High School, MA



Pine River-Backus School, MN



Casework

from WB Manufacturing

We can design, build and deliver quality standard and custom casework for the office, health, education and industrial markets. If one of our 650 standard sizes won't fit your requirements, we can easily meet your needs with our custom capabilities backed by our 10-year warranty. WB Manufacturing is proud to offer Forest Stewardship Council®(FSC®) certified cabinets when the project demands it. Our casework and hardwood benchtops, table tops and locker benches have all been certified with the mark of responsible forestry. For additional information on FSC® certified products, contact our Customer Service Team at 800.242.2303.



The mark of
responsible forestry



University of New Mexico, NM

CaseworkUSA®

Standard and Custom Solutions

For nearly 20 years, WB Manufacturing has been offering a complete line of standard and custom tailored solutions through its cabinet line CaseworkUSA®. We continue to provide superior quality cabinets at budget minded prices making CaseworkUSA® the leader in educational, office, industrial and healthcare markets. If one of our 650 standard cabinets does not meet your needs, contact our Customer Service Team and let WB design, build and deliver your custom solution.

cabinets

CaseworkUSA®

Construction

Nine out of 10 industry professionals who see our cabinets for the first time say, "This is a better built cabinet than I've seen anywhere else." We know. Why do we do it? Because **We Can**. Attention to detail, quality materials, a third more doweling, assembled by hand in Thorp, Wis. -- These are just a few reasons why you, too, should experience and say for yourself, "That truly is a better built cabinet." Our quality-built cabinets are backed with a full service Design Team to oversee your project. WB Manufacturing. Design. Build. Deliver.



CaseworkUSA® Overview

- Case: Fully doweled cabinet, full subtop and 0.5" inset back fully housed at top, bottom and back
- Countertop: 1.25" high pressure laminate (HPL) with 0.75" backsplash (sold separately, field installed)
- Drawers: Fully doweled 0.5" thermal fused laminate (TFL) drawer box with 0.75" HPL front, wire pull
- Drawer Glides: Standard 0.75" undermount (file drawers have full extension side mount steel ball bearing glide)
- Doors: 0.75" HPL, standard wire pull
- Hinges: 6-point adjustable concealed hinge
- Shelves: 0.75" (fixed are fully doweled, adjustable have 4 double-pin shelf clips)
- Finish: Decorative HPL on door and drawer fronts, finished ends and exposed interiors; white drawer boxes, ends and interiors*
- Edge Banding: 0.5mm PVC edge banding on cabinet and shelves, 3mm PVC on doors, drawer fronts and countertop
- Base: 0.75" exterior grade plywood ladder or applied base (vinyl base not included)

*Open units and units with glass doors have matching interior finish.



0.75" fully doweled casebody construction



1.25" HPL countertop (sold separately)



3mm PVC door and drawer matching edge banding



Wire pull (standard)



6-point adjustable hinge (standard)

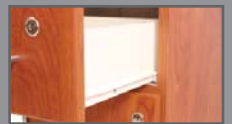

0.75" undermount drawer glide (standard)



Integrated locks (optional)



Plywood ladder or applied base



0.75" shelves and double pin clips



Large grip recessed handle (optional)

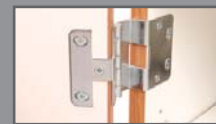

5-knuckle hinge (optional)

HPL Standard Laminate Color Options



*Stocked in limited sizes & quantities. Contact Customer Service for lead time.

Complimentary edgeband option for these laminates, matching edgebanding unavailable.



Complete Laminate Collections Available



Curt Manufacturing, WI

Open Base Cabinets

Model # B1100

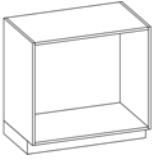

W: 12 - 36" (3" increments)
H: 25, 29, 33 or 35"
D: 14 or 23"
Open
Empty Interior

Model # B1140



W: 12 - 36" (3" increments)
H: 25, 29, 33 or 35"
D: 14 or 23"
Open
1 Adjustable Shelf

Model # B1150



W: 12 - 36" (3" increments)
H: 25, 29, 33 or 35"
D: 14 or 23"
Open
2 Adjustable Shelves

Model # B1110

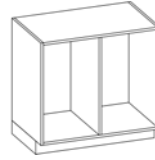

W: 12 - 48" (3" increments)
H: 25, 29, 33 or 35"
D: 14 or 23"
Open
1 Vertical Divider

Model # B1120

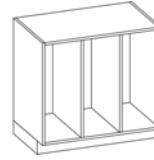

W: 18 - 48" (3" increments)
H: 25, 29, 33 or 35"
D: 14 or 23"
Open
2 Vertical Dividers

Model # B1130

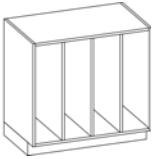

W: 24 - 48" (3" increments)
H: 25, 29, 33 or 35"
D: 14 or 23"
Open
3 Vertical Dividers

Model # B1280



W: 18 - 48" (3" increments)
H: 25, 29, 33 or 35"
D: 14 or 23"
Open
1 Fixed Shelf
1 Half-Height Divider

Model # B1285



W: 18 - 48" (3" increments)
H: 25, 29, 33 or 35"
D: 14 or 23"
Open
1 Fixed Shelf
2 Half-Height Dividers

Model # B1290

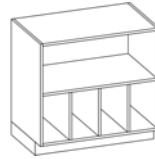

W: 24 - 48" (3" increments)
H: 25, 29, 33 or 35"
D: 14 or 23"
Open
1 Fixed Shelf
3 Half-Height Dividers

Model # B1295

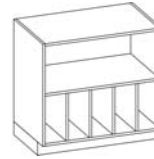

W: 30 - 48" (3" increments)
H: 25, 29, 33 or 35"
D: 14 or 23"
Open
1 Fixed Shelf
4 Half-Height Dividers

Model # B1245



W: 12 - 48" (3" increments)
H: 25, 29, 33 or 35"
D: 14 or 23"
Open
1 Vertical Divider
2 Fixed Shelves

Model # B1145



W: 12 - 48" (3" increments)
H: 25, 29, 33 or 35"
D: 14 or 23"
Open
1 Vertical Divider
2 Adjustable Shelves

Model # B1255



W: 12 - 48" (3" increments)
H: 25, 29, 33 or 35"
D: 14 or 23"
Open
1 Vertical Divider
4 Fixed Shelves

Model # B1155

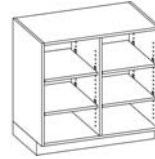

W: 12 - 48" (3" increments)
H: 25, 29, 33 or 35"
D: 14 or 23"
Open
1 Vertical Divider
4 Adjustable Shelves

Model # B1246

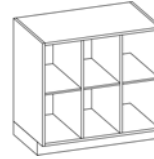

W: 18 - 48" (3" increments)
H: 25, 29, 33 or 35"
D: 14 or 23"
Open
2 Vertical Dividers
3 Fixed Shelves

Model # B1146



W: 18 - 48" (3" increments)
H: 25, 29, 33 or 35"
D: 14 or 23"
Open
2 Vertical Dividers
3 Adjustable Shelves

Model # B1236

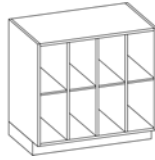

W: 24 - 48" (3" increments)
H: 25, 29, 33 or 35"
D: 14 or 23"
Open
3 Vertical Dividers
4 Fixed Shelves

Model # B1136

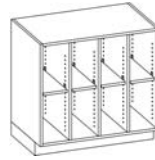

W: 24 - 48" (3" increments)
H: 25, 29, 33 or 35"
D: 14 or 23"
Open
3 Vertical Dividers
4 Adjustable Shelves

Model # B1265

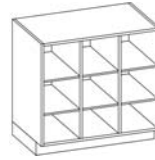

W: 18 - 48" (3" increments)
H: 25, 29, 33 or 35"
D: 14 or 23"
Open
2 Vertical Dividers
6 Fixed Shelves

Model # B1165

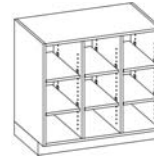

W: 18 - 48" (3" increments)
H: 25, 29, 33 or 35"
D: 14 or 23"
Open
2 Vertical Dividers
6 Adjustable Shelves

Base Cabinet Overview

1. 3/4" fully doweled cabinet body
2. 3/4" drawer face HPL front, white back and 3mm edge banding
3. 1/2" drawer box with undermount drawer slides
4. End panel with line bored holes 32mm on center (when ordered with adjustable shelves)
5. Adjustable shelf, white with 4 double-pin shelf clips**
6. Cabinet interior finished in white**
7. Drawer separator doweled in place
8. 3/4" door, HPL front with white back and 3mm edge banding
9. Standard wire pull
10. Standard 6-point adjustable euro hinges
11. Inset back, fully housed at top, bottom and sides
12. Mounting rails top and bottom
13. 3/4" cabinet bottom
14. 3/4" plywood applied base; ladder base optional
15. 23" standard cabinet body depth
16. 23 7/8" cabinet depth with doors/drawers

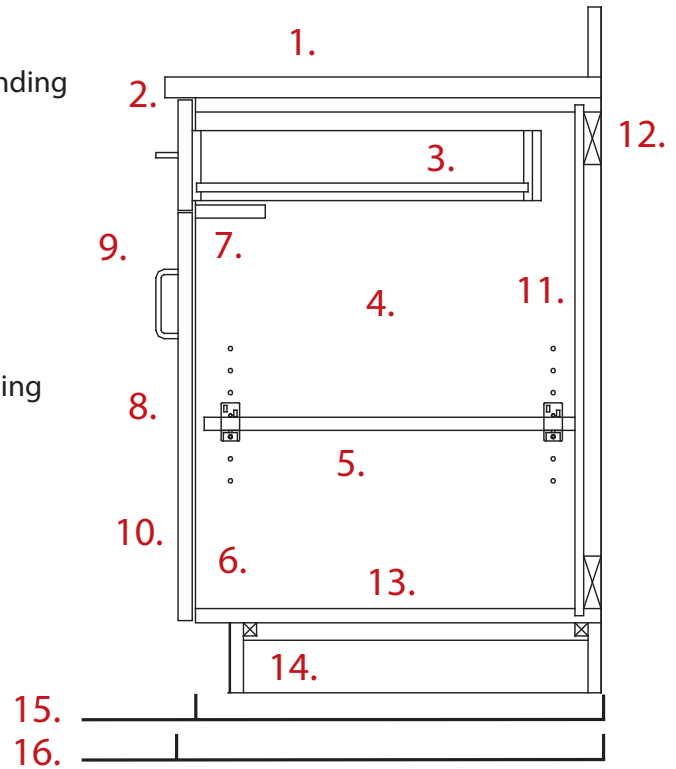

**Open units and units with glass doors have matching interior finish.

Model # B1275



Model # B1175



W: 24 - 48" (3" increments)
 H: 25, 29, 33 or 35"
 D: 14 or 23"
 Open
 3 Vertical Dividers
 8 Fixed Shelves

W: 24 - 48" (3" increments)
 H: 25, 29, 33 or 35"
 D: 14 or 23"
 Open
 3 Vertical Dividers
 8 Adjustable Shelves

Drawer & Door Base Cabinets

Model # B2000



W: 12 - 36" (3" increments)
 H: 29, 33 or 35"
 D: 23"
 Single Drawer Over Open
 Empty Interior

Model # B2010



W: 12 - 36" (3" increments)
 H: 29, 33 or 35"
 D: 23"
 Single Drawer Over Open
 1 Adjustable Shelf

Model # B2304



W: 12 - 48" (3" increments)
 H: 29, 33 or 35"
 D: 23"
 Single Drawer Over Open
 1 Vertical Divider

Model # B2305



W: 12 - 48" (3" increments)
 H: 29, 33 or 35"
 D: 23"
 Single Drawer Over Open
 1 Vertical Divider
 2 Adjustable Shelves

Model # B2200



W: 24 - 36" (3" increments)
 H: 29, 33 or 35"
 D: 23"
 Double Drawer Over Open
 Empty Interior

Drawer & Door Base Cabinets

Model # B2210



W: 24 - 36" (3" increments)
H: 29, 33 or 35"
D: 23"
Double Drawer Over Open
1 Adjustable Shelf

Model # B2404



W: 24 - 48" (3" increments)
H: 29, 33 or 35"
D: 23"
Double Drawer Over Open
1 Vertical Divider

Model # B2405



W: 24 - 48" (3" increments)
H: 29, 33 or 35"
D: 23"
Double Drawer Over Open
1 Vertical Divider
2 Adjustable Shelves

Model # B2100/2105*

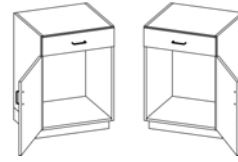

W: 12 - 24" (3" increments)
H: 25, 29, 33 or 35"
D: 23"
Single Drawer Over Door
Left/Right Hinged
Empty Interior

Model # B2110/2120*



W: 12 - 24" (3" increments)
H: 25, 29, 33 or 35"
D: 23"
Single Drawer Over Door
Left/Right Hinged
1 Adjustable Shelf

Model # B2140/2145*

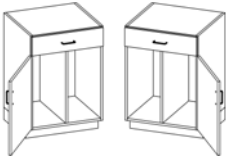

W: 12 - 24" (3" increments)
H: 25, 29, 33 or 35"
D: 23"
Single Drawer Over Door
Left/Right Hinged
1 Vertical Divider

Model # B2170/2175*

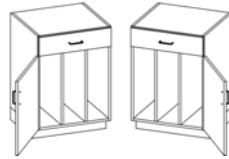

W: 18, 21 or 24"
H: 25, 29, 33 or 35"
D: 23"
Single Drawer Over Door
Left/Right Hinged
2 Vertical Dividers

Model # B2150/2155*

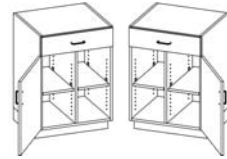

W: 12 - 24" (3" increments)
H: 25, 29, 33 or 35"
D: 23"
Single Drawer Over Door
Left/Right Hinged
1 Vertical Divider
2 Adjustable Shelves

Model # B2180/2185*

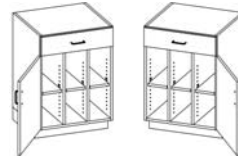

W: 18, 21 or 24"
H: 25, 29, 33 or 35"
D: 23"
Single Drawer Over Door
Left/Right Hinged
2 Vertical Dividers
3 Adjustable Shelves

Model # B2301



W: 24 - 36" (3" increments)
H: 25, 29, 33 or 35"
D: 23"
Single Dwr Over Double Dr
Empty Interior

Model # B2300



W: 24 - 36" (3" increments)
H: 25, 29, 33 or 35"
D: 23"
Single Dwr Over Double Dr
1 Adjustable Shelf

Model # B2302

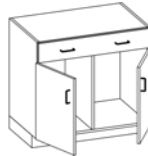

W: 24 - 48" (3" increments)
H: 25, 29, 33 or 35"
D: 23"
Single Dwr Over Double Dr
1 Vertical Divider

Model # B2303

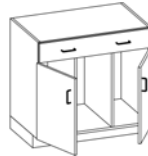

W: 24 - 36" (3" increments)
H: 25, 29, 33 or 35"
D: 23"
Single Dwr Over Double Dr
2 Vertical Dividers

Model # B2325

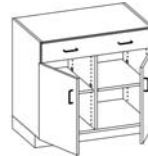

W: 24 - 48" (3" increments)
H: 25, 29, 33 or 35"
D: 23"
Single Dwr Over Double Dr
1 Vertical Divider
2 Adjustable Shelves

Model # B2326

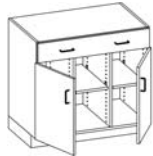

W: 24 - 36" (3" increments)
H: 25, 29, 33 or 35"
D: 23"
Single Dwr Over Double Dr
2 Vertical Dividers
3 Adjustable Shelves

Model # B2401



W: 24 - 36" (3" increments)
H: 25, 29, 33 or 35"
D: 23"
Double Dwr Over Double Dr
Empty Interior

Model # B2400



W: 24 - 36" (3" increments)
H: 25, 29, 33 or 35"
D: 23"
Double Dwr Over Double Dr
1 Adjustable Shelf

Model # B2402



W: 24 - 48" (3" increments)
H: 25, 29, 33 or 35"
D: 23"
Double Dwr Over Double Dr
1 Vertical Divider

Model # B2403

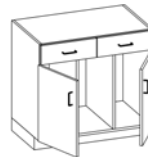

W: 24 - 48" (3" increments)
H: 25, 29, 33 or 35"
D: 23"
Double Dwr Over Double Dr
2 Vertical Dividers

Model # B2425

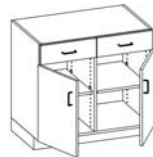

W: 24 - 48" (3" increments)
H: 25, 29, 33 or 35"
D: 23"
Double Dwr Over Double Dr
1 Vertical Divider
2 Adjustable Shelves

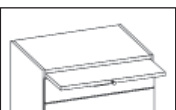

*Add 1 to these SKUs for a drawer with pull out shelf. Example: B2100 becomes B2101

Drawer & Door Base Cabinets

Model # B2426



W: 24 - 48" (3" increments)
 H: 25, 29, 33 or 35"
 D: 23"
 Double Dwr Over Double Dr
 2 Vertical Dividers
 3 Adjustable Shelves

Model # B3000/3005

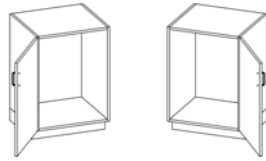

W: 12 - 24" (3" increments)
 H: 29, 33 or 35"
 D: 23"
 Full Height Door
 Left/Right Hinged
 Empty Interior

Model # B3010/3015

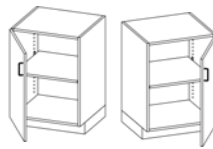

W: 12 - 24" (3" increments)
 H: 29, 33 or 35"
 D: 23"
 Full Height Door
 Left/Right Hinged
 1 Adjustable Shelf

Model # B3110/3120

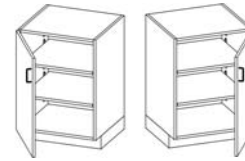

W: 12 - 24 (3" increments)
 H: 25, 29, 33 or 35"
 D: 23"
 Full Height Door
 Left/Right Hinged
 2 Adjustable Shelves

Model # B3200/3205

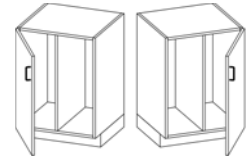

W: 12 - 24 (3" increments)
 H: 25, 29, 33 or 35"
 D: 23"
 Full Height Door
 Left/Right Hinged
 1 Vertical Divider

Model # B3815/3825

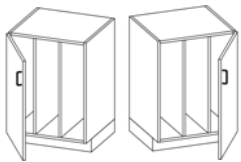

W: 18, 21 or 24"
 H: 25, 29, 33 or 35"
 D: 23"
 Full Height Door
 Left/Right Hinged
 2 Vertical Dividers

Model # B3210/3215

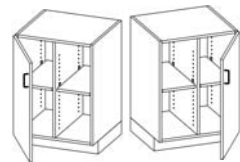

W: 18, 21 or 24"
 H: 25, 29, 33 or 35"
 D: 23"
 Full Height Door
 Left/Right Hinged
 1 Vertical Divider
 2 Adjustable Shelves

Model # B3230/3235

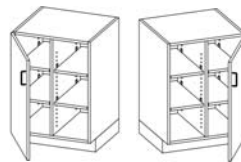

W: 18, 21 or 24"
 H: 25, 29, 33 or 35"
 D: 23"
 Full Height Door
 Left/Right Hinged
 1 Vertical Divider
 4 Adjustable Shelves

Model # B3835/3836

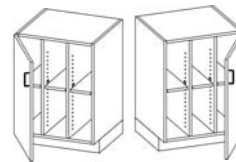

W: 18, 21 or 24"
 H: 25, 29, 33 or 35"
 D: 23"
 Full Height Door
 Left/Right Hinged
 2 Vertical Dividers
 3 Adjustable Shelves

Model # B3865/3866

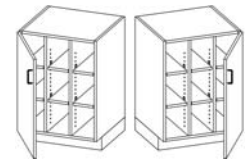

W: 18, 21 or 24"
 H: 25, 29, 33 or 35"
 D: 23"
 Full Height Door
 Left/Right Hinged
 2 Vertical Dividers
 6 Adjustable Shelves

Model # B3100

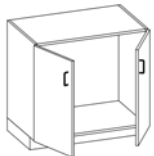

W: 24 - 36" (3" increments)
 H: 25, 29, 33 or 35"
 D: 23"
 Double Full Height Doors
 Empty Interior

Model # B3112



W: 24 - 36" (3" increments)
 H: 25, 29, 33 or 35"
 D: 23"
 Double Full Height Doors
 1 Adjustable Shelf

Model # B3122



W: 24 - 36" (3" increments)
 H: 25, 29, 33 or 35"
 D: 23"
 Double Full Height Doors
 2 Adjustable Shelves

Model # B3101

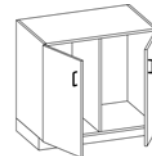

W: 24 - 48" (3" increments)
 H: 25, 29, 33 or 35"
 D: 23"
 Double Full Height Doors
 1 Vertical Divider

Model # B3300

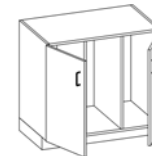

W: 24 - 48" (3" increments)
 H: 25, 29, 33 or 35"
 D: 23"
 Double Full Height Doors
 2 Vertical Dividers

Drawer & Door Base Cabinets

Model # B3145



W: 24 - 48" (3" increments)
H: 25, 29, 33 or 35"
D: 23"
Double Full Height Doors
1 Vertical Divider
2 Adjustable Shelves

Model # B3135

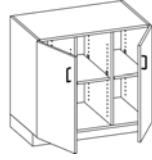

W: 24 - 48" (3" increments)
H: 25, 29, 33 or 35"
D: 23"
Double Full Height Doors
2 Vertical Dividers
3 Adjustable Shelves

Model # B3155



W: 24 - 48" (3" increments)
H: 25, 29, 33 or 35"
D: 23"
Double Full Height Doors
1 Vertical Divider
4 Adjustable Shelves

Model # B3165



W: 24 - 36" (3" increments)
H: 25, 29, 33 or 35"
D: 23"
Double Full Height Doors
2 Vertical Dividers
6 Adjustable Shelves

Model # B3400

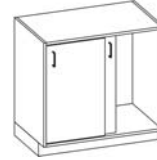

W: 24 - 36" (3" increments)
H: 25, 29, 33 or 35"
D: 23"
Sliding Doors
Empty Interior

Model # B3405



W: 24 - 36" (3" increments)
H: 25, 29, 33 or 35"
D: 23"
Sliding Doors
1 Adjustable Shelf

Model # B3401

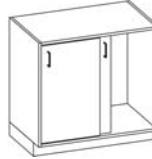

W: 24 - 48" (3" increments)
H: 25, 29, 33 or 35"
D: 23"
Sliding Doors
1 Vertical Divider

Model # B3406

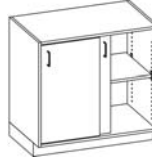

W: 24 - 48" (3" increments)
H: 25, 29, 33 or 35"
D: 23"
Sliding Doors
1 Vertical Divider
2 Adjustable Shelves

Model # B3410

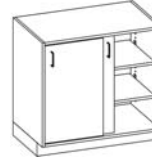

W: 24 - 36" (3" increments)
H: 25, 29, 33 or 35"
D: 23"
Sliding Doors
2 Adjustable Shelves

Model # B3411

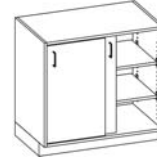

W: 24 - 48" (3" increments)
H: 25, 29, 33 or 35"
D: 23"
Sliding Doors
1 Vertical Divider
4 Adjustable Shelves





We Can.
DESIGN. BUILD. DELIVER.



Stanley School, WI

Drawer Base Cabinets

Model # B6010



W: 12 - 36" (3" increments)
H: 12 or 18"
D: 23"
1 Drawer (non file)

Model # B6020



W: 12 - 36" (3" increments)
H: 29, 33 or 35"
D: 23"
2 Equal Drawers

Model # B6030



W: 12 - 36" (3" increments)
H: 25, 29, 33 or 35"
D: 23"
3 Equal Drawers

Model # B9400/10/20



W: 36 - 48" (3" increments)
H: 29, 33 or 35"
D: 35"
3/4/5 Equal Drawers
(B9420 not available in 29" H)

Model # B6040



W: 12 - 36" (3" increments)
H: 29, 33 or 35"
D: 23"
4 Equal Drawers

Model # B6050



W: 12 - 36" (3" increments)
H: 33 or 35"
D: 23"
5 Equal Drawers

Model # B6060



W: 12 - 36" (3" increments)
H: 33 or 35"
D: 23"
6 Equal Drawers

Model # B6035*



W: 12 - 36" (3" increments)
H: 29, 33 or 35"
D: 23"
1 Standard Drawer (6.125")
2 Equal Drawers

Model # B6045*



W: 12 - 36" (3" increments)
H: 29, 33 or 35"
D: 23"
1 Standard Drawer (6.125")
3 Equal Drawers

Model # B6055*



W: 12 - 36" (3" increments)
H: 29, 33 or 35"
D: 23"
1 Standard Drawer (6.125")
4 Equal Drawers

Model # B6070*



W: 12 - 36" (3" increments)
H: 33 or 35"
D: 23"
2 Standard Drawers (6.125")
2 Equal Drawers

Model # B6075*



W: 12 - 36" (3" increments)
H: 29, 33 or 35"
D: 23"
3 Standard Drawers (6.125")
1 Drawer

Model # B6315



W: 24 - 36" (3" increments)
H: 29, 33 or 35"
D: 23"
1 Double Drawer (6.125")
2 Equal Height Drawers
- 2 Single Drawers

Model # B6415



W: 24 - 36" (3" increments)
H: 29, 33 or 35"
D: 23"
1 Double Drawer (6.125")
3 Equal Height Drawers
- 3 Single Drawers

Model # B6512



W: 24 - 36" (3" increments)
H: 33 or 35"
D: 23"
5 Equal Height Drawers
- 1 Double Drawer
- 4 Single Drawers

Model # B6652



W: 24 - 36" (3" increments)
H: 33 or 35"
D: 23"
6 Equal Height Drawers
- 1 Double Drawer
- 5 Single Drawers

Model # B6515



W: 24 - 36" (3" increments)
H: 33 or 35"
D: 23"
1 Double Drawer (6.125")
4 Equal Height Drawers
- 4 Single Drawers

Model # B9200



W: 15.75 or 18.75"
H: 29 or 33"
D: 23"
2 File Drawers

Model # B9210



W: 15.75 or 18.75"
H: 41"
D: 23"
3 File Drawers

Model # B9215



W: 15.75 or 18.75"
H: 54"
D: 23"
4 File Drawers

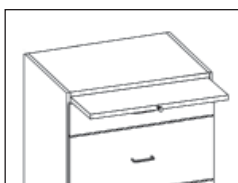

*Add 1 to these SKUs for a drawer with pull out shelf. Example: B6035 becomes B6036, B6070 becomes B6071. Pull out shelf option available up to 24" wide.

Drawer Base Cabinets

Model # B9205*



W: 15.75 or 18.75"
H: 29 or 33"
D: 23"
1 Single Drawer (6.125")
1 Single Drawer (balance)
1 File Drawer

Model # B9220*



W: 15.75 or 18.75"
H: 33 or 35"
D: 23"
1 Single Drawer (6.125")
2 Equal Drawers
1 File Drawers

Model # B9310*



W: 15.75 or 18.75"
H: 35"
D: 23"
1 Single Drawer (6.125")
2 File Drawers

Model # B9230



W: 24, 30 or 36"
H: 29, 33 or 35"
D: 23"
2 Lateral File Drawers



15.75 File Drawer
Letter Size Only



18.75 File Drawer
Letter or Legal Size



Lateral File Drawer
Files Run Side to Side
Letter or Legal Size



*Add 1 to these SKUs
for a drawer with pull
out shelf. Example:
B9205 becomes B9206,
B9220 becomes B9221.

Model # K9100



W: 12 - 36"***
H: 5.25 or 6.5"
D: 20"
Single Book Box
Open

Model # K9101



W: 30 - 48"***
H: 5.25 or 6.5"
D: 20"
Double Book Box
Open

Model # K9105



W: 12 - 24"***
H: 2.5"
D: 20"
Stand Alone
Pull Out Board

Model # K9150



W: 12 - 36"***
H: 3"
D: 20"
Single Book Box
Pull Out Drawer
KL8400 Slide Only

Model # K9200



W: 12 - 36"***
H: 3.25"
D: 20"
Single Book Box
Pull Out Drawer

Model # K9120



W: 12 - 36"***
H: 5.25 or 6.5"
D: 20"
Single Book Box
Pull Out Drawer

Model # K9121



W: 30 - 48"***
H: 5.25 or 6.5"
D: 20"
Double Book Box
Pull Out Drawers

Corner Base Cabinets

Model #	Description	WxHxD
B2800	Open, Empty Interior (Square Inside Corner)	36" x 29, 33, 35" x 36"
B2801	Open, Adjustable Shelf	36" x 29, 33, 35" x 36"
B2802	Open, Rotating Shelf	36" x 33, 35" x 36"
B2805/2815	Left/Right Hinge Door, Empty Interior	36" x 29, 33, 35" x 36"
B2810/2820	Left/Right Hinge Door, Adjustable Shelf	36" x 29, 33, 35" x 36"
B2811/2821	Left/Right Hinge Door, Rotating Shelf	36" x 33, 35" x 36"
B2900	Open, Empty Interior (45° Corner)	36" x 29, 33, 35" x 36"
B2901	Open, Adjustable Shelf	36" x 29, 33, 35" x 36"
B2902	Open, Rotating Shelf	36" x 33, 35" x 36"
B2905/2915	Left/Right Hinge Door, Empty Interior	36" x 29, 33, 35" x 36"
B2910/2920	Left/Right Hinge Door, Adjustable Shelf	36" x 29, 33, 35" x 36"
B2911/2921	Left/Right Hinge Door, Rotating Shelf	36" x 33, 35" x 36"

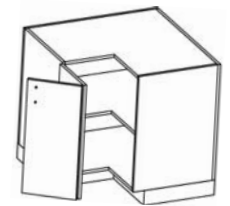

B2810 shown

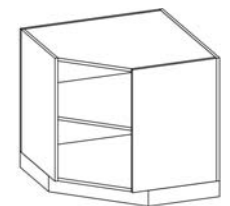

B2901 shown

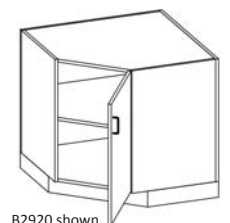

B2920 shown

***3" increments

Blind Corner Base Cabinets

Model # B2500/2501

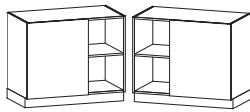

W: 42, 45 or 48"
H: 29, 33 or 35"
D: 23"
Blind Corner
Panel Left/Right
Open
1 Fixed Shelf

Model # B2510/2520

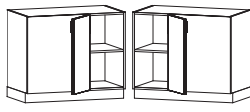

W: 42, 45 or 48"
H: 29, 33 or 35"
D: 23"
Blind Corner
Panel Left/Right
Full Door
1 Fixed Shelf

Model # B2535/2545

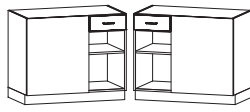

W: 42, 45 or 48"
H: 29, 33 or 35"
D: 23"
Blind Corner
Panel Left/Right
Drawer Over Door
1 Fixed Shelf

Model # B2530/2540

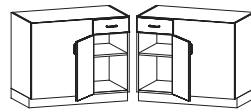

W: 42, 45 or 48"
H: 29, 33 or 35"
D: 23"
Blind Corner
Panel Left/Right
Drawer Over Door
1 Fixed Shelf

Sink Base Cabinets

Model # B4010/4020

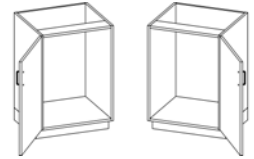

W: 15 - 24" (3" increments)
H: 25, 29, 33 or 35"
D: 23"
Sink Cabinet
Full Height Door
Left/Right Hinged

Sink Base Cabinets

Model # B4110/4120

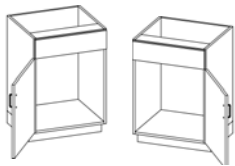

W: 15 - 24" (3" increments)
H: 25, 29, 33 or 35"
D: 23"
Sink Cabinet
Blank Panel
Door Left/Right Hinged

Model # B4002



W: 24 - 48" (3" increments)
H: 25, 29, 33 or 35"
D: 23"
Sink Cabinet
Full Height Double Doors

Model # B4133

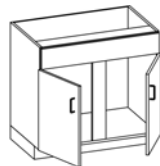

W: 51 - 60" (3" increments)
H: 29, 33 or 35"
D: 23"
Sink Cabinet
Oversized Blank Panel
Double Doors

Model # 4102/4302

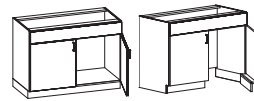

W: 24 - 48" (3" increments)
H: 25, 29, 33 or 35"
D: 23"
Sink Cabinet
Blank Panel
Double Doors
Note: B4302 - Toe kick attached to door; no bottom.

Model # ADAS

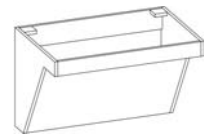

W: 30 - 48" (3" increments)
H: 23.25" (for 34" countertop)
D: 23"
Sink Cabinet
ADA Compliant



Middle County High School, NY

Open Wall Cabinets

Model # W1100

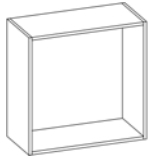

W: 12 - 36" (3" increments)
 H: 12, 15, 18, 24, 30, 36, 42, 48"
 D: 14"
 Open
 Empty Interior

Model # W1110



W: 12 - 36" (3" increments)
 H: 12, 15, 18, 24, 30, 36, 42, 48"
 D: 14"
 Open
 Fixed Shelves*

Model # W1180



W: 12 - 36" (3" increments)
 H: 12, 15, 18, 24, 30, 36, 42, 48"
 D: 14"
 Open
 Adjustable Shelves*

Model # W1175

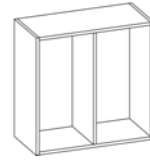

W: 12 - 48" (3" increments)
 H: 12, 15, 18, 24, 30, 36, 42, 48"
 D: 14"
 Open
 1 Vertical Divider

Model # W1185

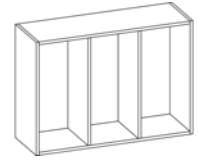

W: 24 - 48" (3" increments)
 H: 12, 15, 18, 24, 30, 36, 42, 48"
 D: 14"
 Open
 2 Vertical Dividers

Model # W1195

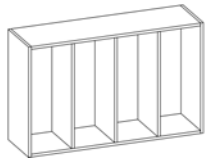

W: 24 - 48" (3" increments)
 H: 12, 15, 18, 24, 30, 36, 42, 48"
 D: 14"
 Open
 3 Vertical Dividers

Model # W1120



W: 12 - 48" (3" increments)
 H: 18, 24, 30, 36, 42, 48"
 D: 14"
 Open
 1 Vertical Divider
 Fixed Shelves*

Model # W1155



W: 24 - 48" (3" increments)
 H: 18, 24, 30, 36, 42, 48"
 D: 14"
 Open
 1 Vertical Dividers
 Adjustable Shelves*

Model # W1130

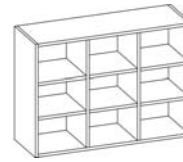

W: 24 - 48" (3" increments)
 H: 18, 24, 30, 36, 42, 48"
 D: 14"
 Open
 2 Vertical Dividers
 Fixed Shelves*

Model # W1165

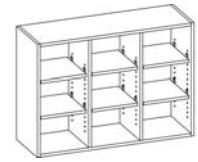

W: 24 - 48" (3" increments)
 H: 18, 24, 30, 36, 42, 48"
 D: 14"
 Open
 2 Vertical Dividers
 Adjustable Shelves*

Model # W1140

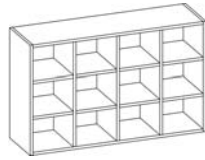

W: 24 - 48" (3" increments)
 H: 18, 24, 30, 36, 42, 48"
 D: 14"
 Open
 3 Vertical Dividers
 Fixed Shelves*

Model # W1170

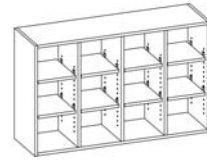

W: 24 - 48" (3" increments)
 H: 18, 24, 30, 36, 42, 48"
 D: 14"
 Open
 3 Vertical Dividers
 Adjustable Shelves*

*Shelf Quantities	
Cabinet Height	# of Shelves
12, 15"	0
18, 24"	1
30, 36"	2
42, 48"	3

Door Wall Cabinets

Model # W2000/2010

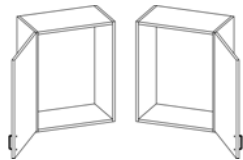

W: 12 - 24" (3" increments)
 H: 12, 15, 18, 24, 30, 36, 42, 48"
 D: 14"
 Single Door
 Left/Right Hinged
 Empty Interior

Model # W2110/2120

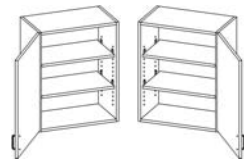

W: 12 - 24" (3" increments)
 H: 18, 24, 30, 36, 42, 48"
 D: 14"
 Single Door
 Left/Right Hinged
 Adjustable Shelves*

Model # W2105



W: 24 - 36" (3" increments)
 H: 12, 15, 18, 24, 30, 36, 42, 48"
 D: 14"
 Double Doors
 Empty Interior

Model # W2182



W: 24 - 36" (3" increments)
 H: 18, 24, 30, 36, 42, 48"
 D: 14"
 Double Doors
 Adjustable Shelves*

Model # W2115



W: 24 - 48" (3" increments)
 H: 12, 15, 18, 24, 30, 36, 42, 48"
 D: 14"
 Double Doors
 1 Vertical Divider

Wall Cabinet Overview

1. 3/4" fully doweled cabinet body
2. End panel with line bored holes 32mm on center (when ordered with adjustable shelves)
3. Adjustable shelf, white with 4 double-pin shelf clips**
4. Cabinet interior finished in white**
5. 3/4" door, HPL front with white back and 3mm edge banding
6. Standard wire pull
7. Inset back, fully housed at top, bottom and sides
8. Mounting rails top and bottom
9. Standard 6-point adjustable hinges
10. 14" standard cabinet body depth
11. 14 7/8" cabinet depth with doors

**Open units and units with glass doors have matching interior finish.

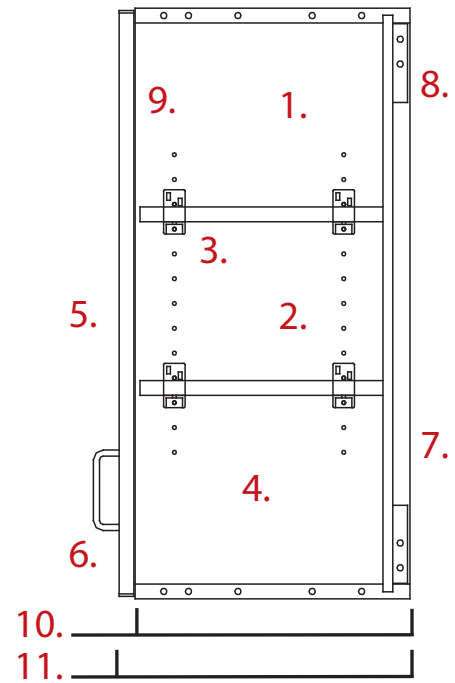

Door Wall Cabinets

Model # W2155



W: 24 - 48" (3" increments)
H: 18, 24, 30, 36, 42, 48"
D: 14"
Double Doors
1 Vertical Divider
Adjustable Shelves*

Model # W2305

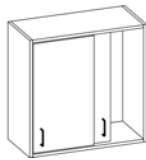

W: 24 - 36" (3" increments)
H: 12, 15, 18, 24, 30, 36, 42, 48"
D: 14"
Double Sliding Doors
Empty Interior

Model # W2315

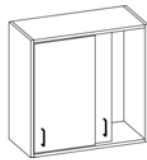

W: 24 - 48" (3" increments)
H: 12, 15, 18, 24, 30, 36, 42, 48"
D: 14"
Double Sliding Doors
1 Vertical Divider

Model # W2382

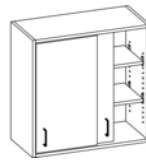

W: 24 - 36" (3" increments)
H: 18, 24, 30, 36, 42, 48"
D: 14"
Double Sliding Doors
Adjustable Shelves*

Model # W2355

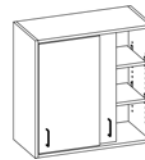

W: 24 - 48" (3" increments)
H: 18, 24, 30, 36, 42, 48"
D: 14"
Double Sliding Doors
1 Vertical Divider
Adjustable Shelves*

Model # W2600/2610

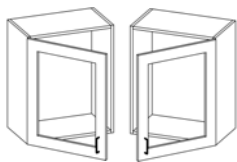

W: 12 - 24" (3" increments)
H: 12, 15, 18, 24, 30, 36, 42, 48"
D: 14"
Single Framed Glass Door
Left/Right Hinged
Empty Interior

Model # W2710/2720

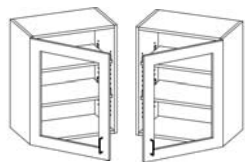

W: 12 - 24" (3" increments)
H: 18, 24, 30, 36, 42, 48"
D: 14"
Single Framed Glass Door
Left/Right Hinged
Adjustable Shelves*

Model # W2605

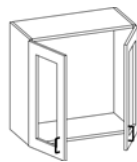

W: 24 - 36" (3" increments)
H: 12, 15, 18, 24, 30, 36, 42, 48"
D: 14"
Double Framed Glass Doors
Empty Interior

Model # W2615



W: 24 - 48" (3" increments)
H: 12, 15, 18, 24, 30, 36, 42, 48"
D: 14"
Double Framed Glass Doors
1 Vertical Divider

Model # W2682



W: 24 - 36" (3" increments)
H: 18, 24, 30, 36, 42, 48"
D: 14"
Double Framed Glass Doors
Adjustable Shelves*

*Shelf Quantities	
Cabinet Height	# of Shelves
12, 15"	0
18, 24"	1
30, 36"	2
42, 48"	3

Door Wall Cabinets

Model # W2655



W: 24 - 48" (3" increments)
H: 18, 24, 30, 36, 42, 48"
D: 14"
Double Framed Glass Doors
1 Vertical Divider
Adjustable Shelves*

Model # W2705

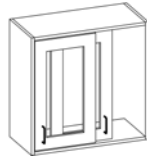

W: 24 - 36" (3" increments)
H: 12, 15, 18, 24, 30, 36, 42, 48"
D: 14"
Framed Sliding Glass Doors
Empty Interior

Model # W2715

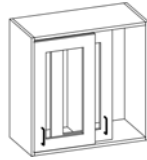

W: 24 - 48" (3" increments)
H: 12, 15, 18, 24, 30, 36, 42, 48"
D: 14"
Framed Sliding Glass Doors
1 Vertical Divider

Model # W2782

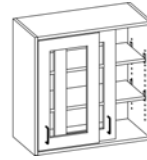

W: 24 - 36" (3" increments)
H: 18, 24, 30, 36, 42, 48"
D: 14"
Framed Sliding Glass Doors
Adjustable Shelves*

Model # W2755

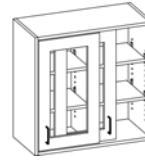

W: 24 - 46" (3" increments)
H: 18, 24, 30, 36, 42, 48"
D: 14"
Framed Sliding Glass Doors
1 Vertical Divider
Adjustable Shelves*

Corner Wall Cabinets

<i>Model #</i>	<i>Description</i>	<i>WxHxD</i>
W2900	Open, Empty Interior (45° Corner)	24" x 18, 24, 30, 36, 42, 48" x 24"
W2901	Open, Adjustable Shelves*	24" x 18, 24, 30, 36, 42, 48" x 24"
W2902	Open, Rotating Shelves	24" x 30, 36" x 24"
W2905/2915	Door, Left/Right Hinged, Empty Interior	24" x 18, 24, 30, 36, 42, 48" x 24"
W2910/2920	Door, Left/Right Hinged, Adjustable Shelves*	24" x 18, 24, 30, 36, 42, 48" x 24"
W2911/2921	Door, Left/Right Hinged, Rotating Shelf	24" x 30, 36" x 24"
W2950/2960	Glass Door, Left/Right Hinged, Open Interior	24" x 18, 24, 30, 36, 42, 48" x 24"
W2951/2961	Glass Door, Left/Right Hinged, Adjustable Shelves*	24" x 18, 24, 30, 36, 42, 48" x 24"
W2952/2962	Glass Door, Left/Right Hinged, Rotating Shelf	24" x 30, 36" x 24"
W2970	Open Empty Interior (Square Inside Corner)	24" x 18, 24, 30, 36, 42, 48" x 14"
W2975/2976	Door, Left/Right Hinged, Adjustable Shelves*	24" x 18, 24, 30, 36, 42, 48" x 14"

<i>*Shelf Quantities</i>	
<i>Cabinet Height</i>	<i># of Shelves</i>
12, 15"	0
18, 24"	1
30, 36"	2
42, 48"	3

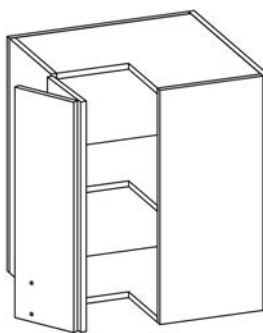

W2975 shown

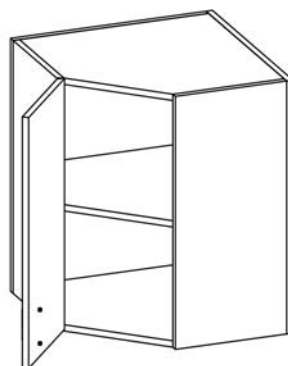

W2910 shown

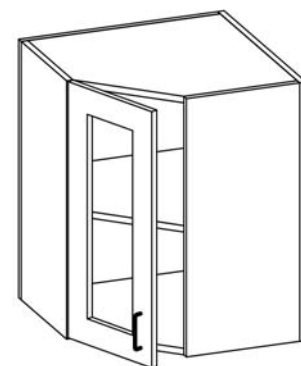

W2951 shown

Each pane of glass in glass doors is a separate piece of 1/4" tempered glass.

Blind Corner Wall Cabinets

Model # W2500/2501

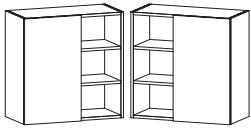

W: 30 - 39" (3" increments)
H: 12, 15, 18, 24, 30, 36, 42, 48"
D: 14"
Blind Corner, Panel Left/Right
Open
Fixed Shelves*

Model # W2510/2520

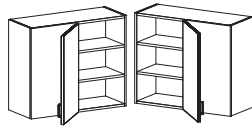

W: 30 - 39" (3" increments)
H: 18, 24, 30, 36, 42, 48"
D: 14"
Blind Corner, Panel Left/Right
Full Door
Fixed Shelves*

Model # W2530/2531

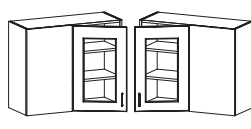

W: 30 - 39" (3" increments)
H: 18, 24, 30, 36, 42, 48"
D: 14"
Blind Corner, Panel Left/Right
Full Glass Door
Fixed Shelves*

*Shelf Quantities	
Cabinet Height	# of Shelves
12, 15"	0
18, 24"	1
30, 36"	2
42, 48"	3



Accessory Wall Cabinets

Model # W2401



W: 24 - 36" (3" increments)
H: 30, 36, 42, 48"
D 14"
Open
Microwave Opening Below
(14" High x 12.375" Deep)
Flush Bottom

Model # W2400



W: 24 - 36" (3" increments)
H: 30, 36, 42, 48"
D 14" (18" Bottom)
Open
Microwave Opening Below
(14" High x 16.375" Deep)
Extended Bottom

Model # W2431

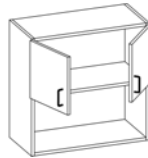

W: 24 - 36" (3" increments)
H: 30, 36, 42, 48"
D 14"
Doors
Microwave Opening Below
(14" High x 12.375" Deep)
Flush Bottom

Model # W2430

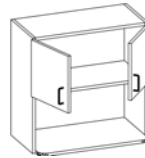

W: 24 - 36" (3" increments)
H: 30, 36, 42, 48"
D 14" (18" Bottom)
Doors
Microwave Opening Below
(14" High x 16.375" Deep)
Extended Bottom

Model # W2441

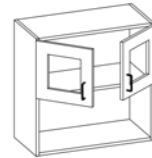

W: 24 - 36" (3" increments)
H: 30, 36, 42, 48"
D 14"
Glass Doors
Microwave Opening Below
(14" High x 12.375" Deep)
Flush Bottom

Model # W2440

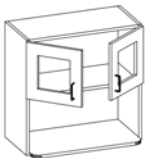

W: 24 - 36" (3" increments)
H: 30, 36, 42, 48"
D 14" (18" Bottom)
Glass Doors
Microwave Opening Below
(14" High x 16.375" Deep)
Extended Bottom

Model # W2991

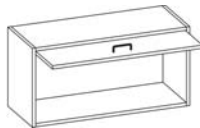

W: 24 - 36" (3" increments)
H: 12, 15, 18"
D: 14"
Flipper Door
Inset Door Openin

Model # W2990

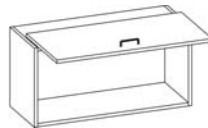

W: 24 - 36" (3" increments)
H: 12, 15, 18"
D: 14"
Flipper Door
Overlay Door Opening

Model # W3101



W: 24, 30, 36, 42, 48"
H: 12"
D: 12"
Wall Shelf
Center Divider (42", 48")

Model # W3100



W: 24, 30, 36, 42, 48"
H: 12"
D: 12"
Wall Shelf
Fixed Clothing Rod
Center Divider (42", 48")

Mail Slots

Model # MSL2556



W: 24"
H: 23"
D: 23"
2 Openings
1 Removable Shelf

Model # MSL2557

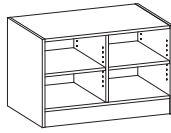

W: 35.625"
H: 23"
D: 23"
4 Openings
2 Removable Shelves
1 Vertical Divider

Model # MSL2558

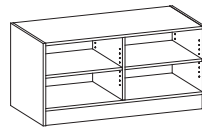

W: 47.25"
H: 23"
D: 23"
4 Openings
2 Removable Shelves
1 Vertical Divider

Model # MSL2553

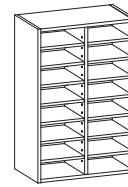

W: 24"
H: 36"
D: 14"
16 Openings
14 Removable Shelves
1 Vertical Divider

Model # MSL2554

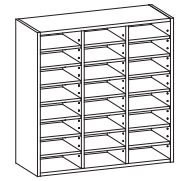

W: 35.625"
H: 36"
D: 14"
24 openings
21 Removable Shelves
2 Vertical Dividers

Model # MSL2550

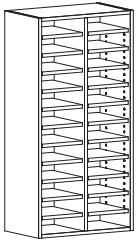

W: 24"
H: 48"
D: 14"
24 Openings
22 Removable Shelves
1 Vertical Divider

Model # MSB2555

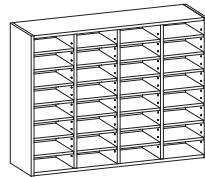

W: 47.25"
H: 36"
D: 14"
32 Openings
28 Removable Shelves
3 Vertical Dividers

Model # MSB2551

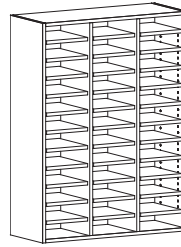

W: 35.625"
H: 48"
D: 14"
36 Openings
33 Removable Shelves
2 Vertical Dividers

Model # MSB2552

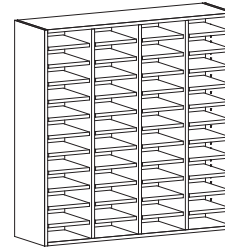

W: 47.25"
H: 48"
D: 14"
48 Openings
44 Removable Shelves
3 Vertical Dividers

Mail Slots are also available with thermal fused laminate construction. Contact Customer Service for details.



Administrative Area

Open Tall Cabinets

Model # T3130

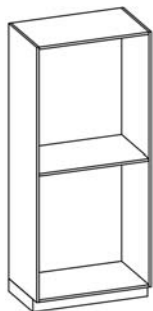

W: 12 - 48" (3" increments)
H: 48, 60, 72 or 84"
D: 14 or 23"
Open
1 Center Fixed Shelf

Model # T1250

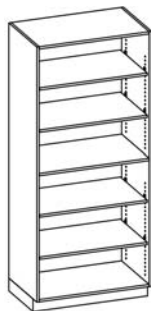

W: 12 - 48" (3" increments)
H: 48, 60, 72 or 84"
D: 14 or 23"
Open, 1 Center Fixed Shelf
Adjustable Shelves
- 2 at 48" and 60" Tall
- 4 at 72" and 84" Tall

Model # T3131

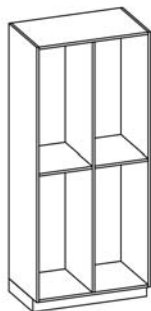

W: 18 - 48" (3" increments)
H: 48, 60, 72 or 84"
D: 14 or 23"
Open
1 Vertical Divider
2 Center Fixed Shelves

Model # T3132

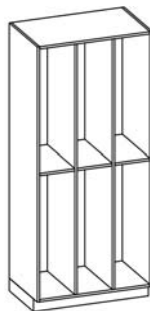

W: 24 - 48" (3" increments)
H: 48, 60, 72 or 84"
D: 14 or 23"
Open
2 Vertical Dividers
3 Fixed Shelves

Model # T3133

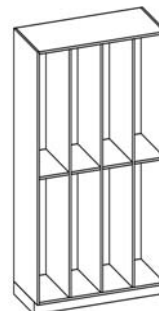

W: 24 - 48" (3" increments)
H: 48, 60, 72 or 84"
D: 14 or 23"
Open
3 Vertical Dividers
4 Fixed Shelves

Model # T1265

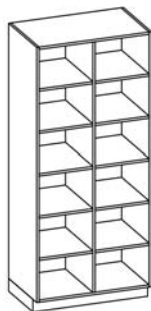

W: 18 - 48" (3" increments)
H: 48, 60, 72 or 84"
D: 14 or 23"
Open, 1 Vertical Divider
Fixed Shelves
- 6 at 48" and 60" Tall
- 8 at 72" Tall
- 10 at 84" Tall

Model # T1255

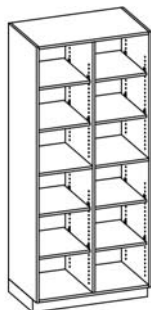

W: 18 - 48" (3" increments)
H: 48, 60, 72 or 84"
D: 14 or 23"
Open, 1 Vertical Divider
2 Fixed Shelves
Adjustable Shelves
- 4 at 48" and 60" Tall
- 8 at 72" and 84" Tall

Model # T1261

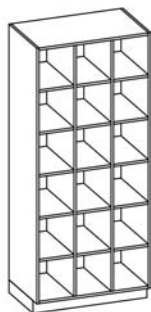

W: 24 - 48" (3" increments)
H: 48, 60, 72 or 84"
D: 14 or 23"
Open, 2 Vertical Dividers
Fixed Shelves
- 9 at 48" and 60" Tall
- 12 at 72" Tall
- 15 at 84" Tall

Model # T1251

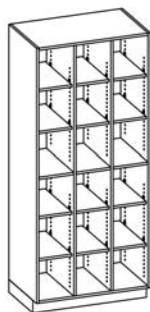

W: 24 - 48" (3" increments)
H: 48, 60, 72 or 84"
D: 14 or 23"
Open, 2 Vertical Dividers
3 Fixed Shelves
Adjustable Shelves
- 6 at 48" and 60" Tall
- 12 at 72" and 84" Tall

Model # T1262

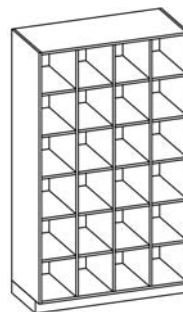

W: 24 - 48" (3" increments)
H: 48, 60, 72 or 84"
D: 14 or 23"
Open, 3 Vertical Dividers
Fixed Shelves
- 12 at 48" and 60" Tall
- 16 at 72" Tall
- 20 at 84" Tall

Model # T1252

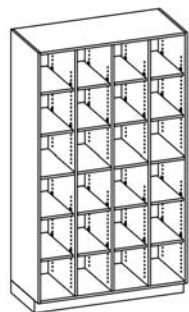

W: 24 - 48" (3" increments)
H: 48, 60, 72 or 84"
D: 14 or 23"
Open, 3 Vertical Dividers
4 Fixed Shelves
Adjustable Shelves
- 8 at 48" and 60" Tall
- 16 at 72" and 84" Tall

Single Door Tall Cabinets

Model # T3200/3201

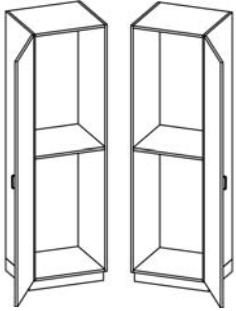

W: 12 - 24" (3" increments)
 H: 48, 60, 72 or 84"
 D: 23"
 Single Door
 Left/Right Hinged
 1 Fixed Shelf

Model # T3210/3220

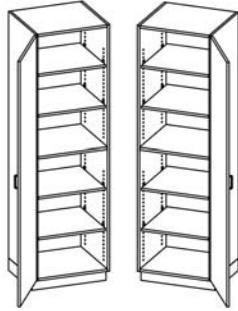

W: 12 - 24" (3" increments)
 H: 48, 60, 72 or 84"
 D: 23"
 Single Door, Left/Right Hinged
 1 Fixed Shelf
 Adjustable Shelves
 - 2 at 48" and 60" Tall
 - 4 at 72" and 84" Tall

Model # T3205/3206

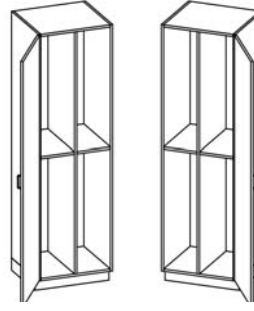

W: 18 - 24" (3" increments)
 H: 48, 60, 72 or 84"
 D: 23"
 Single Door
 Left/Right Hinged
 1 Vertical Divider
 2 Fixed Shelves

Model # T3225/3235

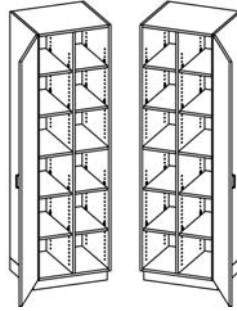

W: 18 - 24" (3" increments)
 H: 48, 60, 72 or 84"
 D: 23"
 Single Door, Left/Right Hinged
 1 Vertical Divider
 2 Fixed Shelves
 Adjustable Shelves
 - 4 at 48" and 60" Tall
 - 8 at 72" and 84" Tall

Model # T3500/3501

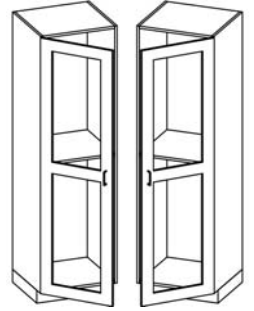

W: 12 - 24" (3" increments)
 H: 48, 60, 72 or 84"
 D: 23"
 Single Split Glass Door
 Left/Right Hinged
 1 Fixed Shelf

Model # T3510/3520

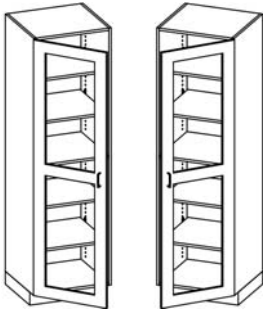

W: 12 - 24" (3" increments)
 H: 48, 60, 72 or 84"
 D: 23"
 Single Split Glass Door
 Left/Right Hinged
 1 Fixed Shelf
 Adjustable Shelves
 - 2 at 48" and 60" Tall
 - 4 at 72" and 84" Tall

Model # T3550/3560

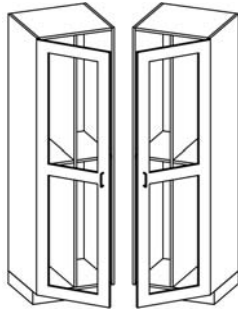

W: 18 - 24" (3" increments)
 H: 48, 60, 72 or 84"
 D: 23"
 Single Split Glass Door
 Left/Right Hinged
 1 Vertical Divider
 2 Fixed Shelves

Model # T3570/3575

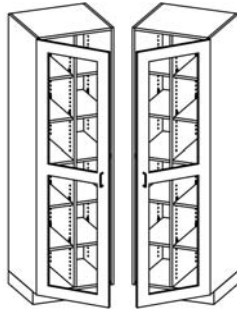

W: 18 - 24" (3" increments)
 H: 48, 60, 72 or 84"
 D: 23"
 Single Split Glass Door
 Left/Right Hinged
 1 Vertical Divider
 2 Fixed Shelves
 Adjustable Shelves
 - 4 at 48" and 60" Tall
 - 8 at 72" and 84" Tall

Each pane of glass in glass doors is a separate piece of 1/4" tempered glass.

Double Door Tall Cabinets

Model # T3100

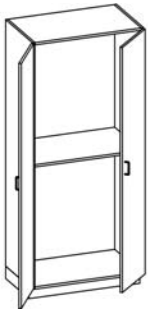

W: 24 - 48" (3" increments)
H: 48, 60, 72 or 84"
D: 23"
Double Doors
1 Fixed Shelf

Model # T3232/3410

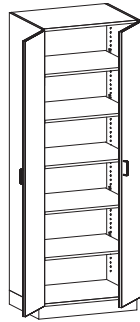

W: 24 - 36" (3" increments)
H: 48, 60, 72 or 84"
D: 23"
Double Doors
1 Fixed Shelf
Adjustable Shelves
- 2 at 48" & 60" Tall
- 4 at 72" & 84" Tall
Note: T3410 has sliding doors

Model # T3105

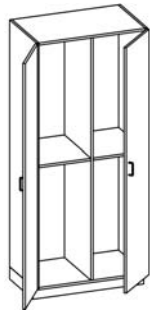

W: 24 - 48" (3" increments)
H: 48, 60, 72 or 84"
D: 23"
Double Doors
1 Vertical Divider
2 Fixed Shelves

Model # T3110

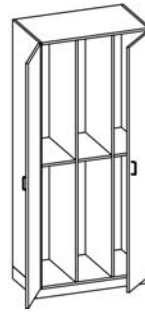

W: 24 - 48" (3" increments)
H: 48, 60, 72 or 84"
D: 23"
Double Doors
2 Vertical Dividers
3 Fixed Shelves

Model # T3170

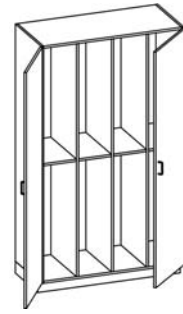

W: 24 - 48" (3" increments)
H: 48, 60, 72 or 84"
D: 23"
Double Doors
3 Vertical Dividers
4 Fixed Shelves

Model # T3222/3411

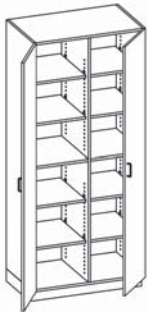

W: 24 - 48" (3" increments)
H: 48, 60, 72 or 84"
D: 23"
Double Doors
1 Vertical Divider
2 Fixed Shelves
Adjustable Shelves
- 4 at 48" and 60" Tall
- 8 at 72" and 84" Tall
Note: T3411 has sliding doors

Model # T3165

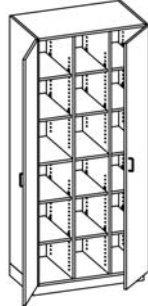

W: 24 - 48" (3" increments)
H: 48, 60, 72 or 84"
D: 23"
Double Doors
2 Vertical Dividers
3 Fixed Shelves
Adjustable Shelves
- 6 at 48" and 60" Tall
- 12 at 72" and 84" Tall

Model # T3180

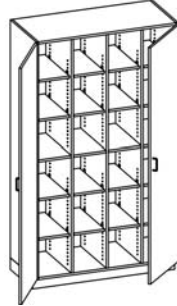

W: 24 - 48" (3" increments)
H: 48, 60, 72 or 84"
D: 23"
Double Doors
3 Vertical Dividers
4 Fixed Shelves
Adjustable Shelves
- 8 at 48" and 60" Tall
- 16 at 72" and 84" Tall

Model # T3600



W: 24 - 48" (3" increments)
H: 48, 60, 72 or 84"
D: 23"
Double Glass Doors
1 Fixed Shelf

Model # T3622

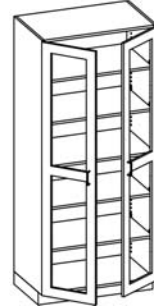

W: 24 - 48" (3" increments)
H: 48, 60, 72 or 84"
D: 23"
Double Glass Doors
1 Fixed Shelf
Adjustable Shelves
- 2 at 48" and 60" Tall
- 4 at 72" and 84" Tall

Model # T5600

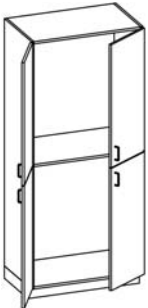

W: 24 - 48" (3" increments)
H: 48, 60, 72 or 84"
D: 23"
Split Double Doors
1 Fixed Shelf

Model # T5622

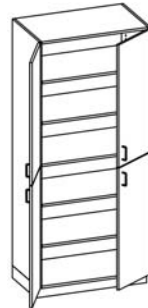

W: 24 - 48" (3" increments)
H: 48, 60, 72 or 84"
D: 23"
Split Double Doors
1 Fixed Shelf
Adjustable Shelves
- 2 at 48" and 60" Tall
- 4 at 72" and 84" Tall

Model # T5700/5705

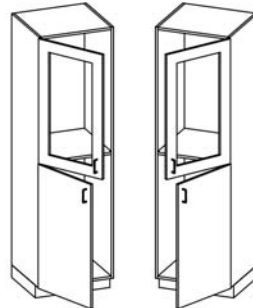

W: 12 - 24" (3" increments)
H: 48, 60, 72 or 84"
D: 23"
Split Doors
Glass Top Door
Solid Bottom Door
Left/Right Hinged
1 Fixed Shelf

Model # T5710/5720

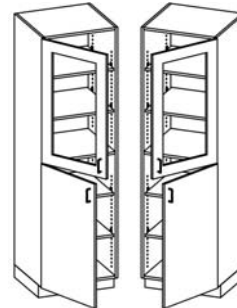

W: 12 - 24" (3" increments)
H: 48, 60, 72 or 84"
D: 23"
Split Doors, Glass Top Door
Solid Bottom Door
Left/Right Hinged
1 Fixed Shelf
Adjustable Shelves
- 2 at 48" and 60" Tall
- 4 at 72" and 84" Tall

Model # T5701/5706

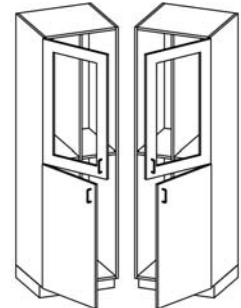

W: 12 - 24" (3" increments)
H: 48, 60, 72 or 84"
D: 23"
Split Doors
Glass Top Door
Solid Bottom Door
Left/Right Hinged
1 Vertical Divider
2 Fixed Shelves

Tall Cabinet Overview

1. 3/4" fully doweled cabinet body
2. End panel with line bored holes 32mm on center (when ordered with adjustable shelves)
3. Adjustable shelf, white with 4 double-pin shelf clips**
4. Cabinet interior finished in white**
5. 3/4" door, HPL front with white back and 3mm edge banding
6. Standard wire pull
7. Inset back, fully housed at top, bottom and sides
8. Mounting rails top, middle and bottom
9. 3/4" cabinet bottom
10. 3/4" plywood applied base; ladder base optional
11. Standard 6-point adjustable hinges
12. 23" standard cabinet body depth
13. 23 7/8" cabinet depth with doors

**Open units and units with glass doors have matching interior finish.

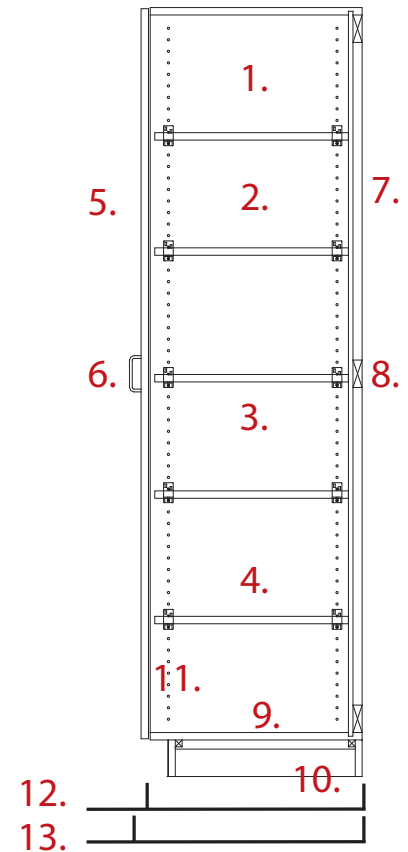

Pine River-Backus School, MN

Double Door Tall Cabinets

Model # T5500/5505

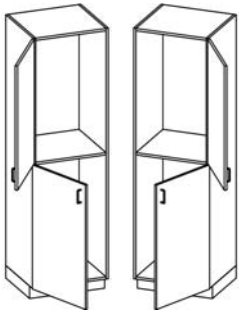

W: 12 - 24" (3" increments)
H: 48, 60, 72 or 84"
D: 23"
Split Doors
Left/Right Hinged
1 Fixed Shelf

Model # T5510/5520

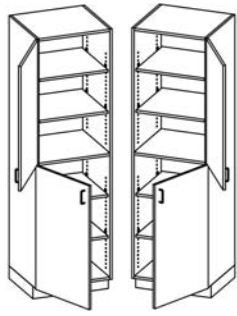

W: 12 - 24" (3" increments)
H: 48, 60, 72 or 84"
D: 23"
Split Doors
Left/Right Hinged
1 Fixed Shelf
Adjustable Shelves
- 2 at 48" and 60" Tall
- 4 at 72" and 84" Tall

Model # T5501/5506

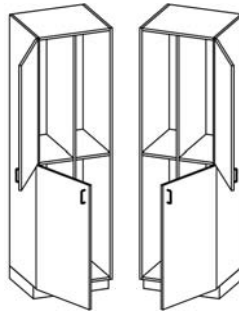

W: 18 - 24" (3" increments)
H: 48, 60, 72 or 84"
D: 23"
Split Doors
Left/Right Hinged
1 Vertical Divider
2 Fixed Shelves

Model # T5511/5521

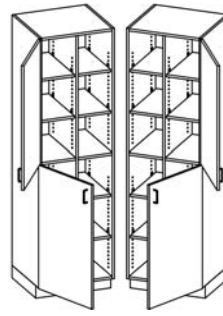

W: 18 - 24" (3" increments)
H: 48, 60, 72 or 84"
D: 23"
Split Doors, Left/Right Hinged
1 Vertical Divider
2 Fixed Shelves
Adjustable Shelves
- 4 at 48" and 60" Tall
- 8 at 72" and 84" Tall

Model # T5711/5721

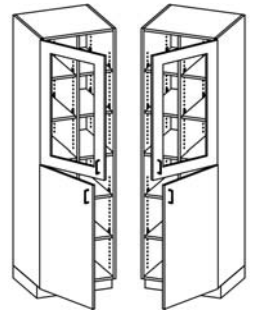

W: 18 - 24" (3" increments)
H: 48, 60, 72 or 84"
D: 23"
Split Doors, Glass Top Door
Solid Bottom Door
Left/Right Hinged
1 Vertical Divider
2 Fixed Shelves
Adjustable Shelves
- 4 at 48" and 60" Tall
- 8 at 72" and 84" Tall

Model # T5605

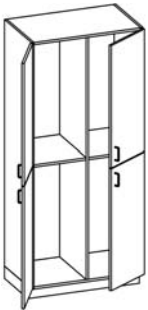

W: 24 - 48" (3" increments)
H: 48, 60, 72 or 84"
D: 23"
Split Double Doors
1 Vertical Divider
2 Fixed Shelves

Model # T5623

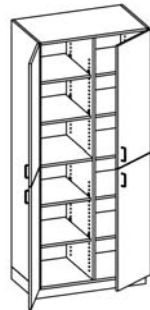

W: 24 - 48" (3" increments)
H: 48, 60, 72 or 84"
D: 23"
Split Double Doors
1 Vertical Divider
2 Fixed Shelves
Adjustable Shelves
- 4 at 48" and 60" Tall
- 8 at 72" and 84" Tall

Model # T5630



W: 24 - 48" (3" increments)
H: 48, 60, 72 or 84"
D: 23"
Split Double Doors
Glass Top Doors
Solid Bottom Doors
1 Fixed Shelf

Model # T5652

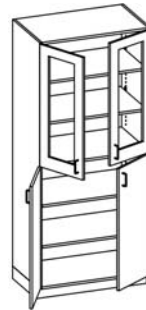

W: 24 - 48" (3" increments)
H: 48, 60, 72 or 84"
D: 23"
Split Double Doors
Glass Top Doors
Solid Bottom Doors
1 Fixed Shelf
Adjustable Shelves
- 2 at 48" and 60" Tall
- 4 at 72" and 84" Tall

Model # T5635

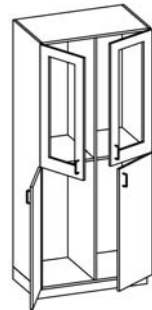

W: 24 - 48" (3" increments)
H: 48, 60, 72 or 84"
D: 23"
Split Double Doors
Glass Top Doors
Solid Bottom Doors
1 Vertical Divider
2 Fixed Shelves

Model # T5653

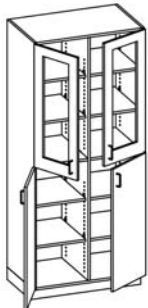

W: 24 - 48" (3" increments)
H: 48, 60, 72 or 84"
D: 23"
Split Double Doors
Glass Top Doors
Solid Bottom Doors
1 Vertical Divider
2 Fixed Shelves
Adjustable Shelves
- 4 at 48" and 60" Tall
- 8 at 72" and 84" Tall

Model # T3605



W: 24 - 48" (3" increments)
H: 48, 60, 72 or 84"
D: 23"
Double Glass Doors
1 Vertical Divider
2 Fixed Shelves

Model # T3610

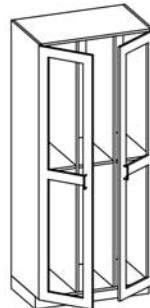

W: 24 - 48" (3" increments)
H: 48, 60, 72 or 84"
D: 23"
Double Glass Doors
2 Vertical Dividers
3 Fixed Shelves

Model # T3655



W: 24 - 48" (3" increments)
H: 48, 60, 72 or 84"
D: 23"
Double Glass Doors
1 Vertical Divider
2 Fixed Shelves
Adjustable Shelves
- 4 at 48" and 60" Tall
- 8 at 72" and 84" Tall

Each pane of glass in glass doors is a separate piece of 1/4" tempered glass.

Model # T3665

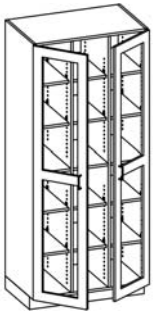

W: 24 - 48" (3" increments)
H: 48, 60, 72 or 84"
D: 23"
Double Glass Doors
2 Vertical Dividers
3 Fixed Shelves
Adjustable Shelves
- 6 at 48" and 60" Tall
- 12 at 72" and 84" Tall

Model # T3680

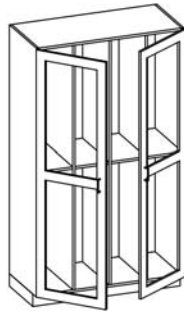

W: 24 - 48" (3" increments)
H: 48, 60, 72 or 84"
D: 23"
Double Glass Doors
3 Vertical Dividers
4 Fixed Shelves

Model # T3690

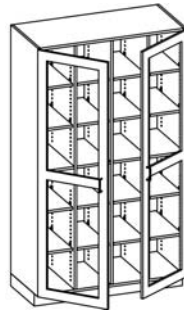

W: 24 - 48" (3" increments)
H: 48, 60, 72 or 84"
D: 23"
Double Glass Doors
3 Vertical Dividers
4 Fixed Shelves
Adjustable Shelves
- 8 at 48" and 60" Tall
- 16 at 72" and 84" Tall

Wardrobe Tall Cabinets

Model # T4100

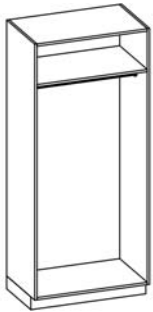

W: 12 - 48" (3" increments)
H: 60, 72 or 84"
D: 23"
Open Wardrobe
1 Fixed Shelf
1 Clothing Rod

Model # T4105

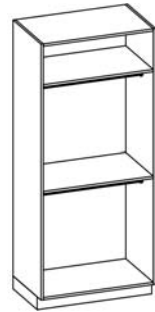

W: 12 - 48" (3" increments)
H: 60, 72 or 84"
D: 23"
Open Wardrobe
2 Fixed Shelves
2 Clothing Rods

Model # T4110/4120

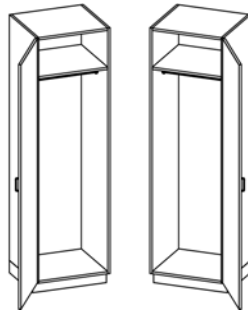

W: 12 - 24" (3" increments)
H: 60, 72 or 84"
D: 23"
Single Door Wardrobe
Left/Right Hinged
1 Fixed Shelf
1 Clothing Rod

Model # T4115/4125

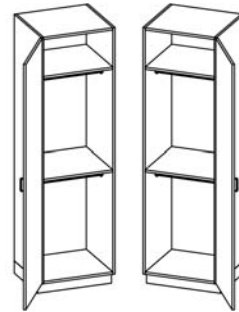

W: 12 - 24" (3" increments)
H: 60, 72 or 84"
D: 23"
Single Door Wardrobe
Left/Right Hinged
2 Fixed Shelves
2 Clothing Rods

Model # T4122

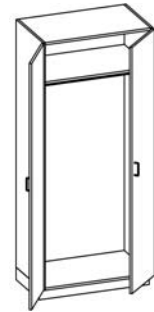

W: 24 - 48" (3" increments)
H: 60, 72 or 84"
D: 23"
Double Door Wardrobe
1 Fixed Shelf
1 Clothing Rod

Model # T4127



W: 24 - 48" (3" increments)
H: 60, 72 or 84"
D: 23"
Double Door Wardrobe
2 Fixed Shelves
2 Clothing Rods

Model # T4222/4224



W: 36 - 48" (3" increments)
H: 72 or 84"
D: 23"
Teacher Wardrobe
1 Vertical Divider, Fixed Shelf,
Coat Rod L 4222/Rt 4224 -10" clear
Adjustable Shelves Right
- 4 at 72" and 84" Tall
Mirror On Back Of One Door

Model # T4324/4322



W: 36 - 48" (3" increments)
H: 72 or 84"
D: 23"
Teacher Wardrobe
1 Vertical Divider, Fixed Shelf,
Coat Rod L 4324/ Rt 4322-10" clear
2 File Drawers Right
Adjustable Shelves Right
- 3 at 72" and 84" Tall
Mirror On Back Of One Door

Casework Accessories

B0001



W: As Needed
H: As Needed
D: 0.75"
Base Scribe/Filler

W0001



W: As Needed
H: As Needed
D: As Needed
Wall Scribe/Filler
Field Assembly
Required

T0001



W: As Needed
H: As Needed
D: 0.75"
Tall Scribe/Filler

B0005



W: As Needed
H: As Needed
D: As Needed
Base Corner Filler
Field Assembly
Required

W0005



W: As Needed
H: As Needed
D: As Needed
Wall Corner Filler
Field Assembly
Required

T0005



W: As Needed
H: As Needed
D: As Needed
Tall Corner Filler
Field Assembly
Required

B0010



W: 3 - 48 (3"
increments)
H: 4.5, 6.125"
D: 0.75"
Apron Panel

B0015



W: 12 - 48" (3"
increments)
H: 25, 29, 33, 35"
D: 0.75"
Knee Space Panel

B0020



W: 12 - 48"
(3" increments)
H: 25, 29, 33, 35"
D: 0.75"
Finished Back
Panel Edged All
Four sides

B0100/B0101



W: 0.75"
H: 25, 29, 33, 35"
D: 22, 28"
Pedestal Support
B0100 Shown,
B0101 Has No
Notch

B0110/B0111



W: 0.75"
H: 25, 29, 33, 35"
D: 22, 28"
Angled Pedestal
B0110 Shown,
B0111 Has No
Notch

B0120/B0121



W: 0.75"
H: 25, 29, 33, 35"
D: 22, 28"
Angled Pedestal
Support
B0120 Shown,
B0121 Has No
Notch

A0001



Sizes (reversible):
5x8, 8x12, 12x18,
15x21, 18x24,
24x24, 24x29"
Countertop
Support Bracket
Metal Angle
Black, White,
Almond, Prime

B0200



W: 3"
H and D: 12x12" -
28x28"
(2" increments
Size Matched)
Laminate
Countertop
Support Bracket

B0300



W: As Needed
H: 4" Back
(3" front)
D: 3"
Laminate Cable
Tray

A0006



W: As Needed
H: 3.25"
D: 1"
Cable Tray
Black Molded
Plastic

A0003



W: 16.75"
H: 5"
D: 14.5"
Standard
Keyboard Tray
Height & Tilt
Adjustable
360° Swivel
Black Injected
Molded

A0005



W: 23.25"
H: 1.75"
D: 18.25"
(extends to 29")
Pencil Drawer
Ball Bearing Slides
5 Compartments
Black Molded
Plastic

W0010



W: 12 - 96"
(3" increments)
H: 2.5, 4"
D: 0.75"
Under Cabinet
Light Valance

W0007



W: 12 - 96"
(3" increments)
H: 3, 6, 9, 12"
D: 0.75"
Soffit Panel
Ceiling Scribe

W0020



W: 12 - 96"
(3" increments)
H: 11.75"
D: 14"
Sloped Top
1.75" Front Face

We Can.
DESIGN. BUILD. DELIVER.

Medford Vet Clinic

Colby, WI

When Medford Vet Clinic opened its satellite clinic in Colby, Wis., they needed standard and custom casework solutions to complete their exam, laboratory, retail, employee and reception areas. WB Manufacturing designed, built and delivered a custom install comprised of our standard casework and shelving and custom in-house design services to create a functional, welcoming space for Medford's employees and clients.





healthwork

BY WB MANUFACTURING

Premium Healthcare Casework

from WB Manufacturing

Whether in exam rooms, lab environments, caregiver stations, respite areas, residence facilities or patient rooms, Healthwork is designed to fit the needs of everyone involved and can easily adapt to meet any challenge both today and tomorrow. WB Manufacturing can design, build and deliver your project from start to finish. We can accommodate your needs with solutions that offer lasting performance and flexibility, backed by a limited lifetime warranty. For details, contact our Customer Service Team at 800.242.2303.



Healthwork

Standard and Custom Solutions

In recent years, WB Manufacturing has been called upon by leaders in the industry to bring its quality products, on-time delivery and competitive pricing to the healthcare market. Working directly with healthcare professionals, WB Manufacturing has developed Healthwork.

Whether in patient or exam rooms, assisted living or long-term care facilities, nursing or reception stations, WB Manufacturing can design, build and deliver healthcare casework and furniture with the functionality and style to meet the needs of your facility. Limited lifetime warranty.

healthwork

H is for Healthwork

Standard and Custom Solutions

Healthwork- Healthcare construction standard listings are listed here in our catalog. If one of our standard cabinets cannot meet the needs of your facility, contact our Customer Service Team and let WB Manufacturing design, build and deliver a custom solution.



Marshfield Clinic, WI

Healthwork - Casework Overview

- Case: Fully doweled 0.75" cabinet, full subtop, inset back
- Countertop: 1.25" high pressure laminate (HPL) with 0.75" backsplash up to 144"L (sold separately, field installed)
- Drawers: Fully doweled 0.75" drawer box with 0.75" front, wire pull standard
- Drawer Glides: Standard full extension side mount glides and file management systems on designated drawers
- Doors: 0.75" doors, wire pull standard on bases, 1" door projection below cabinet standard on uppers
- Hinges: 6-point adjustable concealed hinge, 120°
- Shelves: 0.75" shelf sealed on all sides (shelf is supported with Sekura pins)
- Finish: Decorative HPL on door and drawer fronts, fully finished matching thermal fused laminate (TFL) case and drawer boxes
- Edge Banding: Fully sealed with 0.5mm PVC edge banding on exposed and semi-exposed sides, 1.4mm PVC on doors, drawer fronts and countertop
- Base: 0.75" exterior grade plywood ladder, applied base (vinyl baseboard not included), or fabricated without base



0.75" fully doweled casebody construction



HPL countertop (sold separately)



1" door projection (standard on uppers)



Wire pull (standard on bases)



6-point adjustable hinge (standard)



Full extension side mount drawer glide (standard)



Ladder, applied plywood base



0.75" shelves sealed completely on all sides



0.5mm PVC casebody matching edge banding



1.4mm PVC door and drawer matching edge banding



Integrated single or gang locks (optional)



File drawer system (standard on file drawers)

HPL & TFL Standard Laminate Color Options



WB Solar Oak*



WB Honey Maple*



WB Oiled Cherry*



WB American Cherry*



WB Chestnut Woodline*



WB Black*



WB Hardrock Maple*



WB Folkstone*



WB Antique White*

*Stocked in limited sizes & quantities. Contact Customer Service for lead time.



Marshfield Clinic, WI

Base Cabinets

Model # HB1140



Base Cabinet - Open

W: 12, 15, 16, 18, 21, 24, 27, 30, 32, 33, 36"
H: 28.5, 32.5, 34.5"
D: 20, 24"
Open
1 Adjustable Shelf

Model # HB1150



Base Cabinet - Open

W: 12, 15, 16, 18, 21, 24, 27, 30, 32, 33, 36"
H: 28.5, 32.5, 34.5"
D: 20, 24"
Open, 2 Adjustable Shelves

Model # HB2110/2120

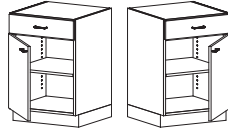

Drawer Storage Base - Single Door

W: 12, 15, 16, 18, 21, 24"
H: 28.5, 32.5, 34.5"
D: 20, 24"
Single Drawer Over Door
Left/Right Hinged
1 Adjustable Shelf

Model # HB2300

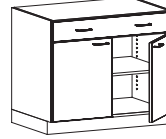

Drawer Storage Base - Double Door w/Drawer

W: 21, 24, 27, 30, 32, 33, 36"
H: 28.5, 32.5, 34.5"
D: 20, 24"
Single Drawer Over Double Door, 1 Adjustable Shelf

Model # HB2400

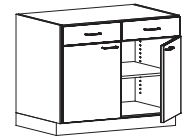

Drawer Storage Base - Double Door/Drawer

W: 24, 27, 30, 32, 33, 36, 39, 42, 45, 48"
H: 28.5, 32.5, 34.5"
D: 20, 24"
Double Drawer Over Double Door, 1 Adjustable Shelf

Model # HB2510/2520

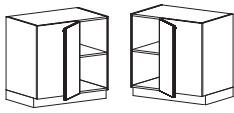

Blind Corner Base Cabinet

W: 36"
H: 28.5, 32.5, 34.5"
D: 20, 24"
Corner Base Left/Right Hinged
1 Fixed Shelf

Model # HB3010/3015

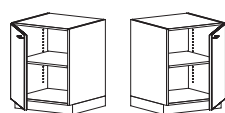

Base Cabinet-Sgl Door

W: 12, 15, 16, 18, 21, 24"
H: 28.5, 32.5, 34.5"
D: 20, 24"
Full Height Door
Left/Right Hinged
1 Adjustable Shelf

Model # HB3050/3060

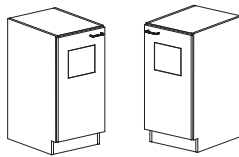

Trash Door Cabinet

W: 16, 18, 21, 24"
H: 28.5, 32.5, 34.5"
D: 20, 24"
8"x10" Top Hinged Trash Door

Model # HB3112

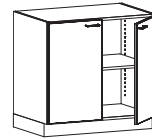

Base Cabinet-DbI Door

W: 21, 24, 27, 30, 32, 33, 36, 39, 42, 45, 48"
H: 28.5, 32.5, 34.5"
D: 20, 24"
Double Full Height Doors
1 Adjustable Shelf

Model # HB4102

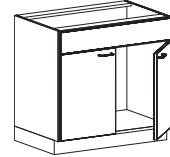

Sink Base - DbI Door

W: 21, 24, 27, 30, 32, 33, 36, 39, 42, 45, 48"
H: 28.5, 32.5, 34.5"
D: 20, 24"
Sink Base Double Doors

Model # HB4110/4120

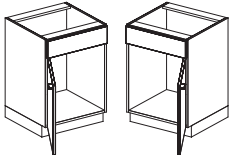

Sink Base - Single Door

W: 24"
H: 28.5, 32.5, 34.5"
D: 20, 24"
Sink Base
Left/Right Hinge

Model # HB4400

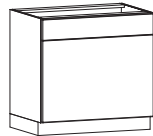

Sink Base w/False Front

W: 21, 24, 27, 30, 32, 33, 36, 39, 42, 45, 48"
H: 28.5, 32.5, 34.5"
D: 20, 24"
Sink Base w/ False Front

Model # HB6020



Base - Double Drawer

W: 32"
H: 28.5, 32.5, 34.5"
D: 20, 24"
2 Equal Drawers

Model # HB6040



Drawer Base Cabinet - 4 Drawer

W: 16, 18, 21, 24, 27, 30, 36"
H: 28.5, 32.5, 34.5"
D: 20, 24"
4 Equal Drawers

Model # HB6070



Drawer Base Cabinet

W: 15, 16, 18, 21, 24"
H: 28.5, 32.5, 34.5"
D: 20, 24"
2 Standard Drawers(6.125")
2 Equal Drawers

Model # HB6075

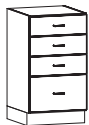

Utility Drawer Base Cabinet

W: 16, 18, 21, 24"
H: 32.5, 34.5"
D: 20, 24"
3 Standard Drawers(6.125")
1 Bottom Drawer depending on Height of Cabinet

Model # HB9200



File Base Cabinet

W: 16, 18, 21"
H: 28.5"
D: 20, 24"
2 File Drawers

Model # HB9205



File Base Cabinet

W: 16, 18, 21"
H: 28.5, 32.5, 34.5"
D: 20, 24"
Top Drawer 6.125", Middle Drawer Depends on Height of Cabinet, Bottom is File Drawer

Model # HB9310



Drawer File Base Cabinet

W: 16, 18, 21"
H: 34.5"
D: 20, 24"
1 Standard Drawer (6.125")
2 File Drawers

Wall and Tall Cabinets

Model # HW1180

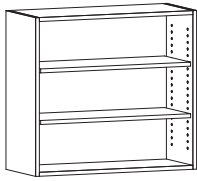

Model # HW2110/2120

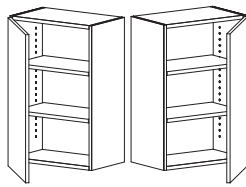

Model # HW2182

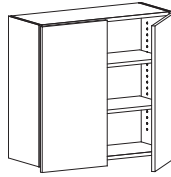

Model # H1T

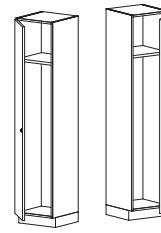

Model # H2T

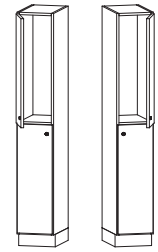

Wall Cabinet - Open

W: 12, 15, 16, 18, 21, 24, 27, 30, 32, 33, 36, 39, 42, 45, 48"
H: 18, 21, 24, 27, 30, 33, 36, 39, 42, 45, 48"
D: 14"

Wall Cabinet - Sgl Door

W: 12, 15, 16, 18, 21, 24"
H: 18, 24, 30, 36, 40, 42, 48"
D: 14"
Single Door Left/Right Hinge

Wall Cabinet -Dbl Door

W: 21, 24, 27, 30, 32, 33, 36, 39, 42, 45, 48"
H: 18, 24, 36, 40, 42, 48"
D: 14"
Double Door

Locker - Single Door

W: 12"
H: 75"
D: 18"
Locker, One Fixed Shelf, Two Interior Coat Hooks

Locker - Double Door

W: 12"
H: 75"
D: 18"
Locker, Double Door

Model # H4T

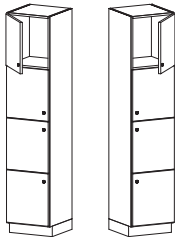

Model # HT1250

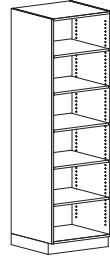

Model # HT3210/3220

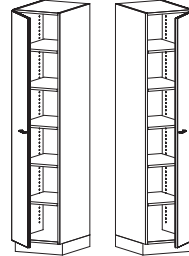

Model # HT3232

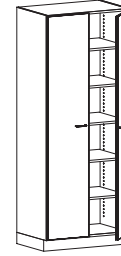

Model # HT4110/4120



Locker - Quad Door

W: 12"
H: 75"
D: 18"
Locker, Quad Door

Tall Storage Cabinet - Open

W: 12, 15, 16, 18, 21, 24, 27, 30, 32, 33, 36, 39, 42, 45, 48"
H: 65, 84"
D: 14, 20, 24"
Open Storage Unit, One Fixed Shelf

Tall Storage Cabinet - Single Door

W: 12, 15, 16, 18, 21, 24"
H: 65, 84"
D: 14, 20, 24"
Single Door, Left/Right Hinge, 1 Fixed Shelf, 2/4 Adjustable Shelves

Tall Storage Cabinet - Double Door

W: 21, 24, 27, 30, 32, 33, 36, 39, 42, 45, 48"
H: 65, 84"
D: 14, 20, 24"
Double Doors, 1 Fixed Shelf, 2/4 Adjustable Shelves

Tall Wardrobe Cabinet - Single Door

W: 15, 16, 18, 21, 24"
H: 65, 84"
D: 24"
Single Door Wardrobe, Left/Right Hinge, 1 Fixed Shelf, 1 Clothing Rod

Model # HT4122

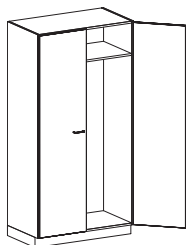

Tall Wardrobe Cabinet - Double Door

W: 24, 27, 30, 32, 33, 36"
H: 65, 84"
D: 24"
Double Door Wardrobe
1 Fixed Shelf
1 Clothing Rod



Marshfield Clinic, WI

Speciality Cabinets

Model # HMS361436

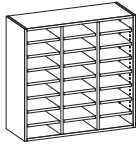

Mail Storage Cabinet

W: 32, 36"
H: 36, 40"
D: 14"
Mail Storage
Bin Openings, 9.625"W,
Varying Height. x 12" D

Model # HWFH10/20

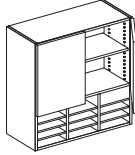

Form Holder Cabinet - Double Door

W: 32"
H: 36, 40"
D: 14"
Double Drs w/1 Adj. Shelf,
12 Opening (9.625") Each,
Varying Height. x 12" D

Model # HW2430

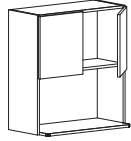

Microwave Cabinet - Double Door

W: 32"
H: 36, 40"
D: 14"
Microwave cabinet, Double
Doors, One Adjustable Shelf

Model # HB8300



Linen Cabinet

W: 30, 32, 33, 36"
H: 28.5, 32.5, 34.5"
D: 24"
Linen Cabinet

Model # HD8110



Prescription Desk - Wall Mounted

W: 34"
H: 17"
D: 16"
Wall Prescription Desk
With Drawer

Model # HD8120

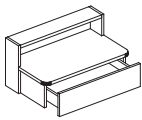

Model # HT1224

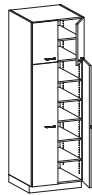

Model # HT1234

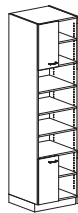

Prescription Desk

W: 34"
H: 11"
D: 17"
Prescription Desk With Drawer

Specialty Storage Cabinet

W: 15, 16, 18, 21, 24"
H: 93"
D: 24"
Specialty Storage
Split Double Doors

Specialty Storage Cabinet - Open

W: 15, 16, 18, 21, 24"
H: 93"
D: 24"
Specialty Storage/ Open
Split Double Doors

We Can. DESIGN. BUILD. DELIVER.

WB (Wisconsin Bench) Manufacturing can **Design** the solutions to meet your environment. Choose from our vast array of furniture and cabinet standards or talk directly to our in-house design team to customize products to fit your space.

We can **Build** it. With over 100 skilled American workforce professionals in our plant in Thorp WI, WB Manufacturing can build what you need when you need it. Utilizing quality materials and processes to ensure affordable, durable, long lasting products backed by a comprehensive warranty.



St. Elizabeth Cancer Hospital, WI

We can **Deliver**. Yes, we can facilitate timely, affordable shipment of your products, but we also "deliver". Deliver the best product, the best customer service and the best solutions for what we hope is the best experience one can have when fulfilling your educational, office, health care and industrial needs. At WB Manufacturing...**We Can**.



Chippewa Valley Orthopedics



Altoona, WI

When Hoeft Builders was looking for quality, flexible, budget-minded casework to meet the needs of Chippewa Valley Orthopedics' new facility, Healthwork cabinets jumped to the top of the list as a perfect fit for exam rooms, MRI suites, rehab areas, reception spaces and nurses stations. Hoeft Builders relied on Healthwork to create a comfortable, healing serenity for patients and a functional workflow for medical staff. Watch the video on our YouTube channel.





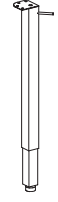
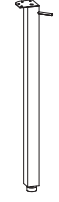
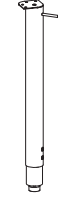
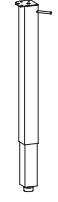
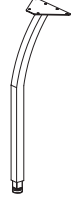

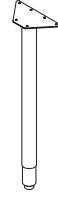
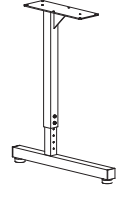
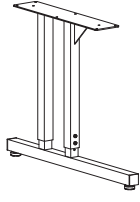





Table & Desk Legs

ALS/JRALS	LOB -ADJ	LOB -FX	LOB -ALR	LOB -ABP	ELO -ADJ/-EJA ELO -ADJSU	ELR -ADJ/-EJA	ELS -ADJ/-EJA	UNE -ADJ UNE -ADJSUF	UNE -ADJ
									
Adjustable or Jr. Activity Leg Black Upper, Chrome Bottom	1.5" LOBO Square Adj. Leg Kit, Black or Smooth Silver	1.5" LOBO Square Fx Leg Kit, Black only	2" LOBO Round Adj. Leg Kit, Black or Smooth Silver	2" LOBO Big Paw Square Adj. Leg Kit, Black only	1.25" ELO Square Adj., Jr. or StandUp Leg Kit, Black or Smooth Silver	2" ELO Curved Round Adj. or Jr. Leg Kit, Black or Smooth Silver	2" ELO Straight Round Adj. or Jr. Leg Kit, Black or Smooth Silver	1.25" UNE-T Square Adj. Leg Kit, Black or Smooth Silver only	1.25" UNE-T Square Adj. Leg Kit, Smooth Silver only

Desk Parts and Accessories

1824	61207-Bolt	33469L/R	-Varies	-TB	-TR	04009313	04009308
							
18 x 24 Hard Plastic Desk Top	700/701 Collar Kit	Left/Right Hinge Lift Lid Desk	Steel Book Box (*varies by model)	Tote Book Box Kit (Tote and Rails)	Tote Rails Only	Long Back pack Hook Smooth Silver(-G4) Black(-X1)	Short Back pack Hook Smooth Silver(-G4) Black(-X1)

Hard Plastic Seats and Accessories

Lg St	St Bk	Rd St	53065	HW14BS	AE14BS	UR14BS
						
Hard Plastic Seat	Hard Plastic Seat Back	Hard Plastic Stool Round Seat	Chair Backpack Chrome Hook	Hardwood Stool Seat	Laminate Stool Seat	Urethane Stool Seat

Stool Seats

Glides

33071	33060	33061	33056	33056S	0401240	33011	33072
							
1" Non-Marring Glide, Great For All VCT Floors	1" Nylon Glide, Great for Carpeted Flooring	1" Steel Glide, Great for VCT or Carpeted Flooring	1.375" Diameter Nylon Glide Threaded	1.25" Diameter Steel Glide 0.375-16S (FModels 872, 873, 874, 876)	1" Square Platform Swivel Glide, Black (Models STL Stools)	1.125" Steel Glide (Models Chrome Fixed Stools)	1.125" Non-Marring Glide (Models Chrome Fixed Stools)

Glide Cont.

040164	Casters* 33020/BK	33021/BK	0400993
			
2.5" Grand Hank Glide, Great for all Tables and Desks	2" (50mm), Dual Wheel Casters (We recommend all braking for tables and desks)	2.375" (60mm), Dual Wheel Casters (We recommend all braking for LOBO 2" sq/rd legs)	3" (250#) Locking Casters

Totes and Trays

5405	0177	9139/9140
		
Glide & Tilt 3" Deep Tote Tray	Glide & Tilt 6" Deep Tote Tray	Tote Tray Dividers Long/Short For use with Glide & Tilt Tote Trays

*Threaded stem casters are to be inserted entirely into the leg to be properly installed. They are NOT to be used as a leveling device, as the capacity ratings are based on the weight being directly transferred to the top of the swivel bearing.

Shelving Rails & Standards

E816366-35



48"W Oval
Horizontal Rail

E816365-35



96"W Oval
Horizontal Rail

14-1093502



Oval Rails End
Caps/Plugs Set

110913-51



Oval Rails
Extension Bracket

100071-35



47.24"H
Vertical Rail

100070-35



78.74"H
Vertical Rail

Shelving Brackets

853088-35



Shelf Bracket
Pair 12"

14-9563534



Middle Bracket
for 853088-35

14-9563524



Shelf Bracket
Pair 16"

14-9563535



Middle Bracket
for 14-9563524

E815050-35



Bookend Shelf
Bracket Pair 12"

14-9563533



Middle Bracket for
12" Bookend

E816296-35



Bookend Shelf
Bracket Pair 16"

14-9563532



Middle Bracket for
16" Bookend

Shelving Standards

WSKV8048/60/72/84



48", 60", 72" or 84"H
Wall Standard

WSKV8548/60/72/84



48", 60", 72" or 84"H
HD Wall Standard

Shelving Brackets

WSKV18012/18



12" or 18"D Bracket

WSKV18512/18/24



12", 18" or 24"D
HD Bracket

It is recommended to add a third bracket for every 3' of running shelving. Consult with a building or plant engineer for proper installation of all shelving.

Not all parts are for all product lines. Contact Customer Service for your specific needs.

Book Boxes & Tote Tray Chart

Item #	Description	Book Box AB-04009603	Book Box DB-04066623	Book Box LB-04066698	Tote Tray TB-0405405	Item / W x D x H
ELO6(7)316	ELO® Loyal			X	X	Book Box: AB-04009603 14.825"x19.124"x4.251"
ELO6(7)317	ELO® Mini Diamond			X	X	
ELO6(7)811	ELO® Mini Tide			X		
ELO6(7)813	ELO® Arcardia			X		Book Box: DB-04066623 18.31"x 20"x4.44"
ELO6(7)400	ELO® Connect 4	X			X	
ELO6(7)216	ELO® Connect 6	Call Estimating	Call Estimating	Call Estimating	Call Estimating	Book Box: LB-04066698 16.31"x14.75"x4.19"
ELO6(7)217	ELO® Connect 8			X	X	
ELO6(7)318	ELO® Diamond		X		X	Tote Tray: TB-0405405 16.732"x12.283"x3.031"
ELO6(7)500	ELO® Ocho	Call Estimating	Call Estimating	Call Estimating	Call Estimating	
ELO6(7)174	ELO® Plymouth 20" x 27.5" (no belly cut)	S		X	X	
ELO6(7)171	ELO® Plymouth II 20" x 27.5" (belly cut)	S		X	X	
ELO6(7)173	ELO® Plymouth II-XL 24" x 36" (belly cut)		X		X	
ELO6(7)600	ELO® Adapt			X	X	
ELO6(7)601	ELO® Adapt XL	S		X	X	
ELO6(7)810	ELO® Adapt II			X	X	
ELO7809	ELO® Mini Nimbus				X	
ELO6(7)813	ELO® Arcardia			X		
ELO6(7)316	ELO® Loyal			X	X	
ELO6(7)811	ELO® Mini Tide			X		
ELO6(7)317	ELO® Mini Diamond			X	X	
ELO6(7)814	ELO® Pyramid	N/A	N/A	N/A	N/A	
ELO6(7)816	ELO® Hurley			X	X	
UNE6(7)500	UNE-T Ocho		X	S	X	
UNE6(7)215	UNE-T Connect 8			X	X	
UNE6(7)362	UNE-T Plymouth 20"x 27" (no belly cut)	S	X	S	X	
UNE6(7)064	UNE-T Plymouth 20"x 36" (no belly cut)	S	X	S	X	
UNE6(7)145	UNE-T Plymouth 24"x 27" (no belly cut)	S	X	S	X	
UNE6(7)067	UNE-T Plymouth XL 24"x 36" (no belly cut)	S	X	S	X	
UNE6(7)363	UNE-T Plymouth II 20" x 27" (belly cut)	S	X	S	X	
UNE6(7)142	UNE-T ADA	S	X	S	X	
UNE6(7)610	UNE-T Adapt		X	S	X	
TOR6(7)215	TORO Connect 8	X		S	X	
TOR6(7)500	TORO Connect 8 Echo Desk			X		

S = Secondary Option



WB Mfg

Wisconsin Bench Manufacturing





WB Manufacturing's plant located in Thorp, WI

WB (Wisconsin Bench) Manufacturing can **Design** the solutions to meet your environment. Choose from our vast array of furniture and cabinet standards or talk directly to our in-house Design Team to customize products to fit your space.

We can **Build** it. With over 100 skilled American workforce professionals in our plant in Thorp, Wis., WB Manufacturing can build what you need when you need it, all the while utilizing quality materials and processes to ensure affordable, durable, long-lasting products backed by a comprehensive

warranty. We can **Deliver**. Yes, we can facilitate timely, affordable shipment of your products, but we also "deliver." Deliver the best product, the best customer service and the best solutions for what we hope is the best experience one can have when fulfilling educational, office, health care and industrial needs. At WB Manufacturing...**We Can**.

We Can.

DESIGN. BUILD. DELIVER.

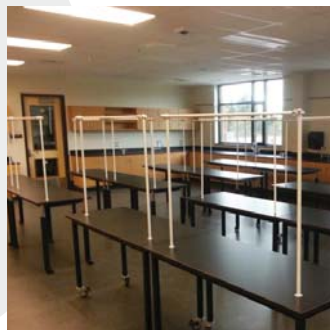

WB Manufacturing Warranty

WB Manufacturing promises to repair or replace any WB Manufacturing brand product or component that is defective in material or workmanship for as long as the original purchaser owns it. This is the sole and exclusive remedy. This warranty is subject to limitations, exclusions or other provisions detailed below.

2 Year Warranty — WB Manufacturing warrants that its lift lid supports, hard and soft plastic seats, backs, tops, plastic bases, high pressure laminated tops, specifically tops for our tables, desks, replacement tops and benches, wood raised and flat panel doors, components and gas cylinders shall be free of substantial defects in original material and workmanship for two (2) years from date of purchase. Cleaning of the high pressure laminate should be done by warm water and a non-abrasive cleaner. Abrasive materials should not be used to clean the surface. Subject to limitations indicated below.

10 Year Warranty — WB Manufacturing guarantees that all laminate furniture are to be compliant with Custom Grade or better, as defined in AWI Standards, Eighth Edition, Revision 2, unless contract documents indicate otherwise.

WB Manufacturing warrants that its laminate furniture, storage solutions, casegoods and lockers and its steel frame products, specifically our desks, tables, chairs and stools shall be free of substantial defects in original material and workmanship for ten (10) years from the delivery date. To be protected under this warranty, all products must be stored in areas of controlled temperature and humidity, and periodic regular scheduled maintenance must be performed.

Warranty Limitations — WB Manufacturing warrants that its products shall be free of substantial defects in original material and workmanship based on specifications from the date of purchase to the extent detailed herein. This warranty is provided only to the initial purchaser, is non-transferable and is valid strictly for as long as the product is owned by the original customer.

This warranty does not cover ordinary wear and tear or involving primary furniture surfaces. In addition, the warranty does not cover defects caused by abusive or abnormal use, modification or alteration, improper assembly/installation, failures resulting from inadequate inspection and maintenance, accident, vandalism or freight damage. Any incidental or consequential damages, including but not limited to business losses, personal property damage, and third party liabilities are hereby expressly excluded.

WB Manufacturing shall repair or replace, at its discretion, any portion of the subject product which proves to be defective under the terms of this warranty. Freight and installation costs are not included. WB Manufacturing may elect to substitute a reasonably comparable product, or a cash refund of the original purchase price (less reasonable depreciation) in the event that the original warranted product is no longer manufactured at the time the warranty is exercised.

There are no implied warranties of fitness or merchantability, and there are no other express warranties beyond the warranties expressed here.





Focus is to Exceed in Green Initiatives

WB Manufacturing, a manufacturer of custom work surfaces, tables, furniture and casework, has adopted a green operations initiative that values environmentally responsible practices in manufacturing and operations of its facility.

WB Manufacturing incorporated a broad range program affecting everything from materials that go into its products to its standards on the manufacturing floor. "The process to go green involved reviewing all areas of the business," said Steve Burgess, President.

Energy consumption is a major expense for the organization, but WB Manufacturing found that with a few simple changes from energy efficient lights on the 200,000 square foot plant to motion sensor light switches in the office area resulted in reduced usage by 54% and significantly lower energy bills. WB Manufacturing also voluntarily participates in the peak load lighting conservation program with the local utility company.

Recycling has always been a standard business practice from using recycled paper in the office equipment and recycled corrugated cardboard for packaging to recycling aluminum cans and plastics. WB Manufacturing even recycles the salvage particle board and MDF scraps using a dedicated shredder to create small bedding particles for local farms.

As part of its green manufacturing focus, WB Manufacturing routinely acquires products like particle board and medium density fiberboard (MDF) with no added urea formaldehyde (NAUF) as well as CARB (California Air Resource Board) compliant materials. "We are constantly evaluating our suppliers to ensure that their products are constructed using recycled wood fiber, as well as providing CARB compliant core materials," added Lane Whitted, Purchasing Manager.

CARB established standards for wood products made with urea-formaldehyde resin products being sold or manufactured in the State of California. The stated goals of CARB include attaining and maintaining healthy air quality; protecting the public from exposure to toxic air contaminants; and providing innovative approaches for complying with air pollution rules and regulations. In selecting MDF and particle board for manufacturing, WB Manufacturing selects Environmentally Preferred Products made from 100% recycled or recovered fiber.

WB Manufacturing products can also assist clients with earning Leadership in Energy and Environmental Design (LEED®) points. Project Managers should specify which LEED point categories are targeted to aid in compliance.

Our other "green" initiatives include development of FSC® certified casework and participation in various important industry programs.

WB Manufacturing continues to focus its operation on complying with manufacturing standards that puts the health and welfare of the planet and our people first. Our focus is to exceed in green initiatives and standards.

Visit wibenchmfg.com to learn more about our involvement in the following programs:

- Forest Stewardship Council
- Eco-Certified Composite Standard
- California Air Resource Board
- U.S. Green Building Council, LEED Program

Standard Finishes

Other color and finish options are available with extended lead times and possible upcharges. For specific color matching, please request color chip from the Mfg.

HPL Standard Laminate Colors

WB Kensington Maple* (-KA)	WB Fusion Maple* (-94)	WB Bannister Oak* (-32)	WB American Cherry* (-Z09)	WB Wild Cherry* (-AA)	WB Montana Walnut* (-66)
WB Black* (-09)	WB Grey Nebula* (-25)	WB Dove Grey* (-05)	WB Khaki Brown* (-EM)	WB Almond* (-04)	WB White* (-03)
WB Hollyberry (-60)	WB Woolamai Brush (-HL)	WB Ocean (-A41) WB Tangerine (-C09) WB Basket Weaving (-A91) WB Eggplant (-D08)			
*Stocked in limited sizes & quantities. Contact Customer Service for lead time.					

Complimentary edgeband option for these laminates, matching edgbanding unavailable.

HPL Electrostatic Discharge/Chemical Resistant Laminate Colors

White (-03)	Almond (-04)	Grey (-05)	Black (-09)
-------------	--------------	------------	-------------

TFL Standard Laminate Colors

WB Solar Oak* (-DX)	WB Honey Maple* (-FV)	WB Oiled Cherry* (-SR)	WB American Cherry* (-Z09)	WB Chestnut Woodline* (-A24)	WB Black* (-09)
WB Hardrock Maple* (-HM)	WB Folkstone* (-FS)	WB Antique White* (-HJ)	*Stocked in limited sizes & quantities. Contact Customer Service for lead time.		

Lotz Armor Edge™ Colors

Black (Standard)	Dove Grey* (-S04)	Slate Grey* (-S05)	Indigo* (-S03)	Plum* (-S07)
------------------	-------------------	--------------------	----------------	--------------

*Upcharge for colors

PVC Edgebanding Colors

WB White* (-03)	WB Almond* (-04)	WB Dove Grey* (-05)	WB Black* (-09)	WB Kensington Maple (-KA)	WB Fusion Maple (-94)
WB Bannister Oak (-32)	WB American Cherry (-Z09)	WB Wild Cherry (-AA)	WB Montana Walnut (-66)	WB Grey Nebula (-25)	WB Khaki Brown (-EM)
WB Hollyberry (-60)	WB Woolamai Brush (-HL)	*Edgebanding stocked in various thickness'.			

Standard Finishes

Other color and finish options are available with extended lead times and possible upcharges. For specific color matching, please request color chip from the Mfg.

Hard Plastic Desktop Colors



*Stocked Hard Plastic Colors

Hard Plastic Square Seat/Back Colors



*Stocked Hard Plastic Colors

1 Piece Soft Plastic Seat Colors

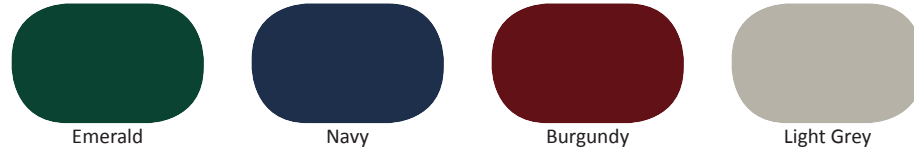

Hard Plastic Round Stool Seat Colors

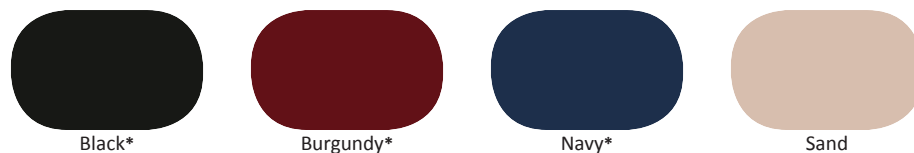

*Stocked Hard Plastic Colors

Tables*/Desks/BookBoxes Frame Colors

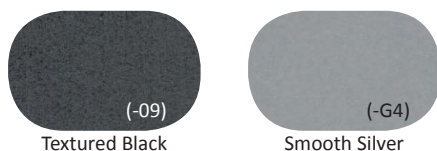

*Activity Table Legs(ALS) are textured black upper/adjustable chrome leg insert lower.



Wisconsin Bench Manufacturing



We Can.
DESIGN. BUILD. DELIVER.

507 E. Grant St., Thorp, WI 54771
P - 800.242.2303
F - 715.669.5929

wibenchmfg.com